

CASO®

D E S I G N

INNOVATIVE KITCHEN TECHNOLOGY



COMPETENCE BOOK WINE COOLERS

No.4

# IT DEPENDS ON THE TEMPERATURE

Whether red wine with an aromatic bouquet; a crisp white wine; a well-chilled beer or cool summer drinks, CASO Design wine and barbecue coolers ensure maximum enjoyment.

Ice cube makers and ice cream machines deliver that extra helping of coolness. If you like tasty, tender meat, you will love the CASO Design Dry Aged Cooler. There is no better way to get the best out of your meat!

Enjoy with  
CASO Design





# CONTENT

|  |    |
|--|----|
| Wine Cooler for one bottle                                     | 9  |
| Wine Cooler  | 10 |
| CASO Control App   | 11 |
| Wine Cooler with the CASO Control App and Built-In Wine Cooler | 21 |
| Barbecue Cooler & Barbecue Cooler with the CASO Control App    | 25 |
| Beer Dispenser   | 27 |
| Lounge Table with sound bar and cooling compartments           | 29 |
| Dry-Aging  | 31 |
| Social Media & websites  | 32 |
| Overview   | 42 |





## Wine Cooler for one bottle

**VinoCase Black**

Item 615

Special functions



Sensor-Touch

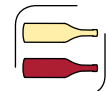

For red and white wine

- + Modern table-top wine cooler, ideal to maintain the temperature of an already chilled bottle of wine, champagne, sparkling wine, etc.
- + **Suitable for all bottles with a diameter up to 9 cm**
- + High-quality, elegant matt black housing – enables you to perfectly stage your favourite wine on any table/ sideboard
- + **Temperature electronically adjustable from 5 to 18 °C\* in 1 °C - increments (or 41 to 64 °F in 1 °F increments) – for the optimum drinking temperature**
- + White LED temperature display with practical sensor touch controls
- + **Quiet operation**
- + Compact size for space-saving storage



\* The achievable value in the interior can not exceed the ambient temperature at the installation site.

## Wine Cooler for one bottle

**WineCase One Inox**

Item 611

Special functions



Sensor-Touch



Stainless steel housing



For red and white wine

- + High quality wine cooler for one bottle (up to 9 cm Ø)
- + **Ideal for maintaining the temperature of an already cooled bottle of wine, champagne, sparkling wine, etc.**
- + Put your favourite wine in the limelight
- + Noble design with stainless steel housing
- + Compact size – perfect on every sideboard
- + **Temperature electronically adjustable from 5 - 18 °C\* in 1 °C steps (or 41 - 64 °F in 1 °F steps)**
- + White LED temperature display
- + Practical sensor touch operation

**WineCase One Inox Black** | Item 614

- + Like WineCase One Inox, but with black stainless steel housing



## Cordless wine cooler for 1 bottle

**WineCase Deluxe Inox****NEW**

Item 616

Special functions



Sensor-Touch



Stainless steel housing

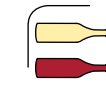

For red and white wine



Cordless

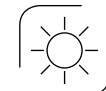

Outdoor

**Wine Cooler:**

- + **Your perfect companion for dinner and barbecues, at the table and on the patio**
- + High-quality, battery-powered wine cooler for one bottle (up to 90 mm Ø) – the perfect addition to your dinner, barbecue, etc.
- + Ideal for maintaining the temperature of a chilled bottle of wine, champagne, sparkling wine, etc.
- + **Precisely tempers your wine at the desired temperature thanks to battery operation for up to 120 minutes\*\***
- + Stylish design with high-quality stainless steel housing
- + Can be operated with battery or power adapter (even without battery)
- + **Temperature can be set electronically from 5 - 18 °C in 1 °C-steps (or 41 - 64 °F in 1 °F-steps)**
- + White LED temperature display
- + Practical sensor touch operation
- + Quiet operation
- + Incl. removable battery (charging time approx. 2 hours) and battery adapter with power supply (additional spare battery available separately)



\*\* Depending on the set ambient and wine temperature

## Battery

**WineCase Deluxe Inox-Akku****NEW**

Item 617



# Wine Cooler

## WineComfort 24 black

Item 644

Special functions →



Sensor-Touch



2 zones for red and white wine



UV protection

- + High quality wine cooler with compressor technology
- + **Two separate temperature zones for white and red wine, individually adjustable via sensor touch operation**
- + Smooth running compressors on vibration-reduced feet: provide the calm, quiet location your wine requires
- + **Storage of up to 24 bottles (up to 310 mm height)\***
- + 3-layer insulating glass with UV filter for optimum aroma protection

- + **Temperature electronically adjustable from 5 - 20 °C (41 - 68 °F)\*\***
- + LED temperature display of the cooling zones
- + Switchable interior lighting
- + Timeless design and elegant handle
- + Five wood storage shelves
- + Lockable door

\* Bottle size based on a standard Bordeaux bottle (max. Ø 75 mm)  
\*\* The achievable value in the interior can not exceed the ambient temperature at the installation site



24



Cooling & Dry Aging

## Smart Kitchen

### Temperature control easily via the CASO Control app

Every wine has its own character which becomes more pronounced as it ages. CASO Design wine refrigerators provide the ideal conditions required for this process. Our Wi-Fi-enabled appliances can also be easily controlled using a smartphone – even if you're not at home. The free CASO control app is essential for this and can be used to check and control your wine refrigerator's storage temperature and lighting.

#### NEW: Temperature Profiles in the App Portal

Our latest enhancement allows you to select custom temperature profiles online. They include both the pre-set profiles "Standard Celsius" and "Standard Fahrenheit" as well as energy-saving profiles "Eco Celsius" and "Eco Fahrenheit". To get even more enjoyment out of your wine cooler you can also create your own profiles – perfectly customised to suit your life.

#### NEW: LED light strips dimmable via smartphone

The built-in appliances in the WineDeluxe WD series have dimmable LED light strips to create a special atmosphere. You can now easily control the 4 light intensity levels via the app.

#### Summary:

- Perfect temperature and light control from virtually anywhere
- App development "Made in Germany"
- Monitors your wine cooler
- Easy light control from almost anywhere
- NEW! Enhanced features in the app portal: Choose pre-set (Standard/Eco) or custom temperature profiles
- NEW for all WineDeluxe WC built-in wine coolers – LED light strips with 4 dimmable light intensity levels
- Free for Android and iOS

[www.casocontrol.com](http://www.casocontrol.com)



SCAN ME  
DOWNLOAD





## Wine coolers

Series **WineComfort Smart**Special  
functionsStainless steel  
housing

Sensor-Touch

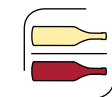
2 zones for red  
and white wine

Appable



UV protection

- + High quality wine control device with compressor technology
- + **Via integrated Wi-Fi module and with the CASO app controllable from almost anywhere**
- + **CASO app monitors and reports any errors in seconds**
- + Two separate temperature zones, individually adjustable for white & red wine
- + Sensor-touch operation
- + Smooth running compressors on vibration-reduced feet: provide the calm, quiet location your wine requires
- + **Active fans per temperature zone ensuring a very even temperature per zone**
- + 3-layer insulating glass with UV filter for optimum aroma protection
- + **Temperature electronically adjustable from 5 - 20 °C (41 - 68 °F)\*\***
- + LED temperature display of the cooling zones
- + Switchable interior lighting
- + Timeless design with elegant stainless steel front and ergonomic handle
- + With lockable door



With a wooden storage shelf with a device for presenting your best wines (model WineComfort 1260 Smart und 1800 Smart)



Temperature control easily  
via CASO Control App



24



38



66



126



180

**WineComfort 240 Smart | Art.Nr. 719**

- + Storage for up to 24 bottles (up to 310 mm in height)\*
- + Six wood storage shelves (five of them with ball bearing extensions)

**WineComfort 380 Smart | Art.Nr. 720**

- + Storage for up to 38 bottles (up to 310 mm in height)\*
- + Seven wood storage shelves (six of them with ball bearing extensions)

**WineComfort 660 Smart | Art.Nr. 725**

- + Storage for up to 66 bottles (up to 310 mm in height)\*
- + Seven wood storage shelves (six of them with ball bearing extensions)

**WineComfort 1260 Smart | Art.Nr. 728**

- + Storage for up to 126 bottles (up to 310 mm in height)\*
- + Seven wood storage shelves (six of them with ball bearing extensions) incl. one with a device for presenting your best wines

**WineComfort 1800 Smart | Art.Nr. 730**

- + Storage for up to 180 bottles (up to 310 mm in height)\*
- + Eight wood storage shelves (even of them with ball bearing extensions) incl. one with a device for presenting your best wines

\*Bottle size based on a standard Bordeaux bottle (max. Ø 75 mm)  
\*\* The achievable value in the interior can not exceed the ambient temperature at the installation site



# Wine coolers

## Series WineExclusive Smart

Special functions



Sensor-Touch



1 zone for red and white wine



2 zones for red and white wine



Appable



UV protection

- + High quality wine cooler with compressor technology
- + **Via integrated Wi-Fi Module and with the CASO Control App contrrollable from almost everywhere**
- + **Two separate temperature zones for white and red wine, individually adjustable via sensor touch operation**
- + Smooth running compressors on vibration-reduced feet: provide the calm, quiet location your wine requires
- + **Storage for up to 24 / 38 / 66 / 126 / 180 bottles (up to 310 mm height)\***

- + **3-layer insulating glass with UV filter for optimum aroma protection (WineExklusive 180 Smart 2-layer)**
- + Temperature electronically adjustable from 5 - 20 °C (41 - 68 °F)\*\*
- + LED temperature display of the cooling zones
- + Switchable interior lighting
- + Elegant design glass front
- + Lockable door



With a wooden storage shelf with a device for presenting your best wines (model WineExklusive 126 / 180 Smart)



Temperature control easily via CASO Control App



\* Bottle size based on a standard Bordeaux bottle (max. Ø 75 mm)  
 \*\* The achievable value in the interior can not exceed the ambient temperature at the installation site

- WineExclusive 12 | Art.Nr. 716**
- + Active fans ensuring a very even temperature
  - + **1 temperature zone**
  - + 3 wood storage shelves (2 of them with ball bearing extensions)

- WineExclusive 24 Smart | Art.Nr. 718**
- + Six wood storage shelves (five of them with ball bearing extensions)

- WineExclusive 38 Smart | Art.Nr. 721**
- + **Active fans per temperature zone ensuring a very even temperature per zone**
  - + Seven wood storage shelves (six of them with ball bearing extensions)

- WineExclusive 66 Smart | Art.Nr. 726**
- + **Active fans per temperature zone ensuring a very even temperature per zone**
  - + Seven wood storage shelves (six of them with ball bearing extensions)

- WineExclusive 126 Smart | Art.Nr. 729**
- + **Active fans per temperature zone ensuring a very even temperature per zone**
  - + Seven wood storage shelves (six of them with ball bearing extensions) incl. one with a device for presenting your best wines

- WineExclusive 180 Smart | Art.Nr. 731**
- + **Active fans per temperature zone ensuring a very even temperature per zone**
  - + Eight wood storage shelves (seven of them with ball bearing extensions) incl. one with a device for presenting your best wines

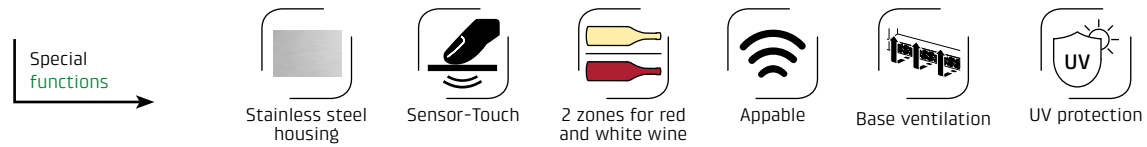

## Wine coolers with base ventilation

Series **WineChef Pro**

- + **WiFi Smart Control – comfortable control from almost anywhere due to the innovative CASO Control App**
- + **CASO app monitors and reports any errors in seconds**
- + Two separate temperature zone, per zones temperature electronically adjustable from 5 - 20 °C (41 - 68 °F)\*\*
- + High quality stainless steel design
- + Sensor-Touch operation
- + **Active fans per temperature zone ensuring a very even temperature per zone**
- + Smooth running compressors on vibration-reduced feet: provide the calm, quiet location your wine requires
- + **Thanks to cooling above the device base, it can be used free-standing or can be built under (WineChef Pro 40) resp. convertible (WineChef Pro 126 / 126-2D / 180)**
- + 3-layer insulating glass for optimal protection
- + White LED temperature display of the cooling zones
- + Switchable interior lighting
- + Lockable door



Temperature control easily via CASO Control App

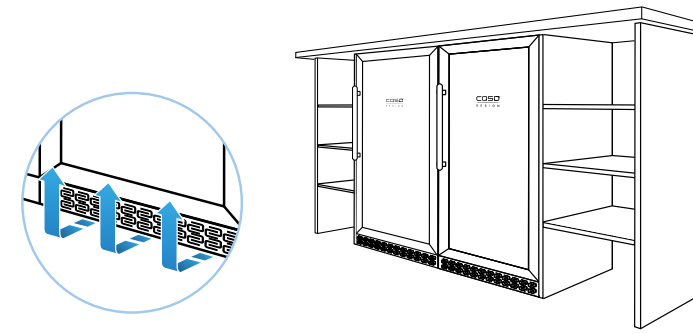

The ventilation located at the front of the device under the base makes it possible to use wine refrigerators both as freestanding appliances as well as convertible and integrated models.

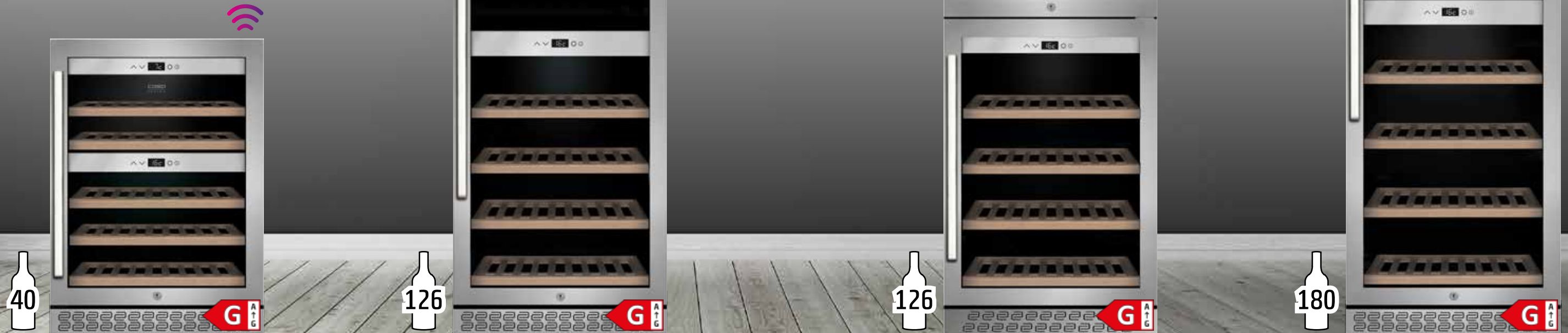

With a wooden storage shelf that can be tilted to display your wines (for models WineChef Pro 126, 126-2D, 180)

**WineChef Pro 40 | Art.Nr. 772**

- + Storage for up to 40 bottles\*
- + Five wood storage shelves (four of them with ball bearing extensions)

**WineChef Pro 126 | Art.Nr. 775**

- + Storage for up to 126 bottles\*
- + Seven wood storage shelves (six of them with ball bearing extensions) incl. one with a device for presenting your best wines

**WineChef Pro 126-2D | Art.Nr. 776**

- + **With two doors for each zone**
- + Storage for up to 126 bottles\*
- + Seven wood storage shelves (six of them with ball bearing extensions) incl. one with a device for presenting your best wines

**WineChef Pro 180 | Art.Nr. 779**

- + Storage for up to 180 bottles\*
- + Seven wood storage shelves (six of them with ball bearing extensions) incl. one with a device for presenting your best wines

\* Bottle size based on a standard Bordeaux bottle (max. Ø 75 mm)  
\*\* The achievable value in the interior can not exceed the ambient temperature at the installation site



## Wine coolers with base ventilation

### Series **WineChef Pro Black**



- + **WiFi Smart Control – comfortable control from almost anywhere due to the innovative CASO Control App**
- + High quality wine cooler with compressor technology
- + Smooth running compressors on vibration-reduced feet: provide the calm, quiet location your wine requires
- + **Thanks to cooling above the device base, it can be used freely or can be built under / resp. convertible**
- + **Two separate temperature zones for white and red wine, individually adjustable**
- + **Temperature electronically adjustable from 5 - 20 °C (41 - 68 °F)\*\***
- + Active fans per temperature zone ensuring a very even temperature per zone
- + 3-layer insulating glass with UV filter for optimum aroma protection
- + Sensor-touch operation
- + White LED temperature display of the cooling zones
- + Switchable interior lighting
- + Timeless design with elegant, black stainless steel front and ergonomic handle
- + Lockable door



126



180



40

#### WineChef Pro 40 Black | Art.Nr. 773

- + Storage for up to 40 bottles (up to 310 mm height)\*
- + Five wood storage shelves (four of them with ball bearing extensions)

#### WineChef Pro 126-2D Black | Art.Nr. 777

- + **With two doors for each zone**
- + Storage for up to 126 bottles\*
- + Seven wood storage shelves (six of them with ball bearing extensions) incl. one with a device for presenting your best wines

#### WineChef Pro 180 Black | Art.Nr. 780

- + Storage for up to 180 bottles\*
- + Seven wood storage shelves (six of them with ball bearing extensions) incl. one with a device for presenting your best wines

\* Bottle size based on a standard Bordeaux bottle (max. Ø 75 mm)  
 \*\* The achievable value in the interior can not exceed the ambient temperature at the installation site

## Built-in wine coolers

### Series **WeinSafe 18 EB**

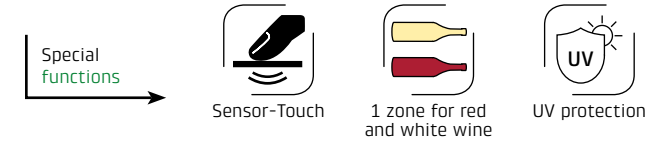

- + High quality wine control device with compressor technology
- + One temperature zone
- + Smooth running compressors on vibration-reduced feet: provide the calm, quiet location your wine requires
- + Storage for up to 18 bottles (up to 310 mm in height)\*
- + 3-layer insulating glass with UV filter for optimum aroma protection
- + Temperature electronically adjustable from 5 - 20 °C (41 - 68 °F)\*\*
- + **Active fan ensures a very even temperature**
- + LED temperature display of the cooling zone
- + Switchable interior lighting
- + **Timeless and elegant design**
  - 627: Glass front and minimalist handle
  - 629: Stainless steel frame and minimalist handle
- + Three removable wood storage shelves (two of them with ball bearing extensions)



The wooden storage shelves are easy to pull out.

**Note! No standard kitchen furniture installation dimensions!**  
 Wine cooler hinge from above / door swings out

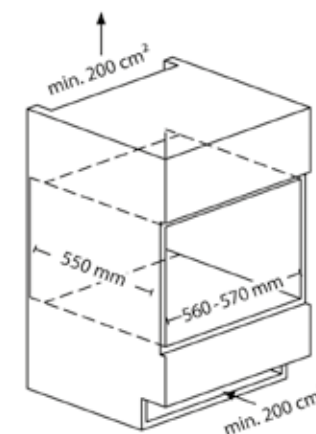
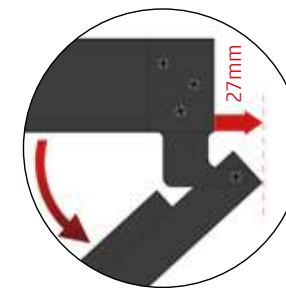
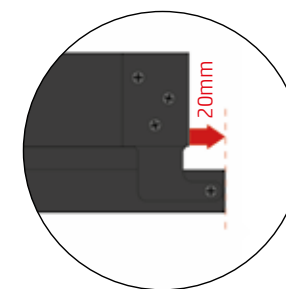

Item 627



WineSafe 18 EB Black

Item 629



WineSafe 18 EB Inox

\* Bottle size based on a standard Bordeaux bottle (max. Ø 75 mm)  
 \*\* The achievable value in the interior can not exceed the ambient temperature at the installation site



## Wine coolers with base ventilation

### Taste is a question of the temperatur



## Wine coolers with base ventilation

### WineChef Duo 122 Black

Item 674

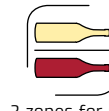

Sensor-Touch

2 zones for red  
and white wine

Base ventilation



UV protection

- + High-quality wine cooler with compressor technology
- + Storage for up to 122 wine bottles\*
- + **Two separate temperature zones, individually adjustable for the right and left side**
- + Sensor-touch display with LED temperature indicators for both zones and quick-select options for preferred settings
- + Temperature range electronically adjustable from 5 - 20 °C (41 - 68 °F)\*\*
- + **Active fan ensures consistent temperature distribution**
- + Quiet-running compressor: Provides the tranquility your wine needs
- + 3-layer insulating safety glass with UV filter for optimal aroma protection
- + **Can be used freestanding or built-in thanks to cooling over the appliance base**
- + Equipped with 13 wave-shaped wire shelves and 4 metal shelves
- + Side-mounted interior LED lighting beautifully showcases your wine
- + Timeless black design with elegant tinted glass front
- + Comes with a lockable door

**NEW**

122

\* Bottle size based on a standard Bordeaux bottle (max. Ø 75 mm)

\*\* The achievable value in the interior can not exceed the ambient temperature at the installation site



## Wine coolers

Taste is a question of the temperatur

Temperature control easily  
via CASO Control App

## Wine coolers

## WineSafe 300 Smart

Item 664

Special  
functions

Sensor-Touch

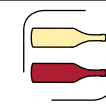
For red and  
white wine

Appable

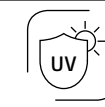

UV protection

- + High-quality wine cooler with compressor technology for a storage for up to 300 bottles\*
- + One temperature zone
- + Intuitive sensor-touch operation
- + Smooth-running compressors on vibration-reduced feet: Ensures the tranquility your wine needs
- + **Active fans ensure consistent temperature distribution across all levels**
- + 2-layer insulating safety glass with UV filter for optimal aroma protection
- + **Electronically adjustable temperature range from 5 - 20 °C (41 - 68 °F)\*\***
- + **Remote control via integrated Wi-Fi and the CASO Control App**
- + LED temperature display for the cooling zone
- + Timeless black design with elegant tinted glass front
- + 11 removable wooden shelves
- + Comes with a lockable door

**NEW**

300



\* Bottle size based on a standard Bordeaux bottle (max. Ø 75 mm)  
 \*\* The achievable value in the interior can not exceed the ambient temperature at the installation site



## Outdoor Cooling

## BBQ-Cooler S-R | S-L



Item 700 / Item 701

## Outdoor Cooling

## BBQ-Cooler Black S-R | S-L



Item 702 / Item 703

## Outdoor Cooling

## BBQ-Cooler M-R



Item 696

## Outdoor Cooling

## BBQ-Cooler L-R



Item 697

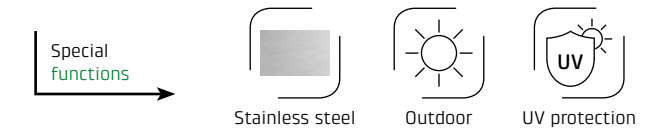
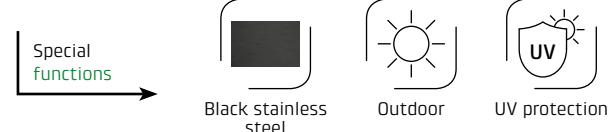
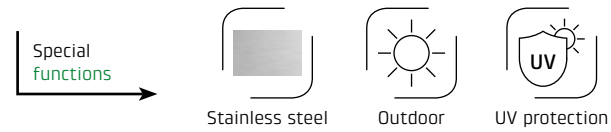

+ **Design barbecue cooler with high-quality stainless steel housing and compressor technology**

+ Versions:

- 700 / BBQ-Cooler S-R: Door hinge on the right
- 701 / BBQ-Cooler S-L: Door hinge on the left

+ **Ideal for interior and exterior use (splash water protection according to IPX-4, e.g. for covered terraces)**

- + 6 adjustable temperature increments (-1 - 10 °C)
- + A lot of space for beverages and foods due to ca. 63 l interior volume
- + 4 practical iron chrome shelves with height adjustability thanks to easy click system
- + Also suitable as a built-in device, e.g. for kitchens, outdoor kitchens and basement party rooms
- + **3-layer, tinted UV safety glass for optimal protection and reliable cooling of the drinks and foods**
- + Overview of how many drinks are still being cooled
- + Door with self-closing mechanism reliable cooling
- + **Interior made of hygienic stainless steel for an easy cleaning**
- + Connectible LED interior illumination

+ **Like BBQ-Cooler S, but with high-quality black stainless steel housing**

+ Versions:

- 702 / BBQ-Cooler Black S-R: Door hinge on the right
- 703 / BBQ-Cooler Black S-L: Door hinge on the left



+ **Design barbecue cooler with high-quality stainless steel housing and compressor technology**

+ **Ideal for interior and exterior use (splash water protection according to IPX-4, e.g. for covered terraces)**

- + 6 adjustable temperature increments (ca. -1 - 10 °C)
- + A lot of space for beverages and foods due to ca. 125 l interior volume
- + 4 practical shelves with height adjustability thanks to easy click system
- + **Also suitable as a built-in device, e.g. for kitchens, outdoor kitchens and basement party rooms**
- + **3-layer, tinted UV safety glass for optimal protection and reliable cooling of the drinks and foods**
- + Overview of how many drinks are still being cooled
- + Door with self-closing mechanism reliable cooling
- + **Interior made of hygienic stainless steel for an easy cleaning**
- + Connectible LED interior illumination
- + Suitable for professional catering as well as for household use

+ **Like BBQ-Cooler M-R, only with a generous 190 l interior volume**



## Outdoor Cooling

**BBQ-Deluxe R Smart****NEW**

Item 707

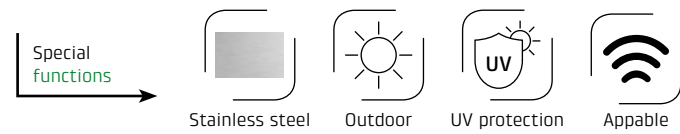

- + **Design barbecue cooler with digital touch display and compressor technology**
- + **High-quality stainless steel housing – Ideal for interior and exterior use (e.g. for covered terraces)**
- + **Can be controlled from anywhere via the integrated Wi-Fi module with the CASO app**
- + Temperature levels adjustable in 1 °C steps (approx. -1 - 10 °C)
- + A lot of space for beverages and foods due to ca. 63 l interior volume
- + 3 practical iron chrome shelves
- + **3-layer, tinted UV safety glass for optimal sun protection and reliable cooling of the drinks and foods**
- + Lockable door with self-closing mechanism reliable cooling
- + **Interior made of hygienic stainless steel for an easy cleaning**
- + Connectible LED interior illumination

## Outdoor Cooling

**BBQ-Deluxe L Smart****NEW**

Item 708

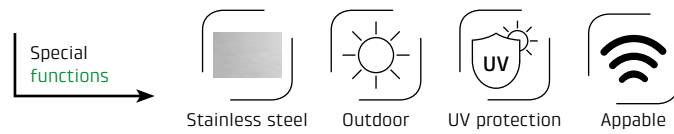

- + **Like BBQ-Deluxe R Smart, but with door hinge on the left**



## Outdoor Cooling

**BBQ-Deluxe Black R Smart****NEW**

Item 709

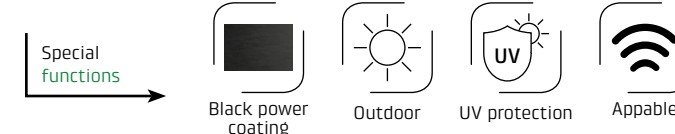

- + **Design barbecue cooler with digital touch display and compressor technology**
- + **High-quality steel housing with matt black weather-resistant powder coating**
- + **Ideal for interior and exterior use (e.g. for covered terraces)**
- + **Can be controlled from anywhere via the integrated Wi-Fi module with the CASO app**
- + Temperature levels adjustable in 1 °C steps (approx. -1 - 10 °C)
- + A lot of space for beverages and foods due to ca. 63 l interior volume
- + 3 practical iron chrome shelves
- + **3-layer, tinted UV safety glass for optimal sun protection and reliable cooling of the drinks and foods**
- + Lockable door with self-closing mechanism reliable cooling
- + **Interior made of hygienic stainless steel for an easy cleaning**
- + Connectible LED interior illumination

## Outdoor Cooling

**BBQ-Deluxe Black L Smart****NEW**

Item 710

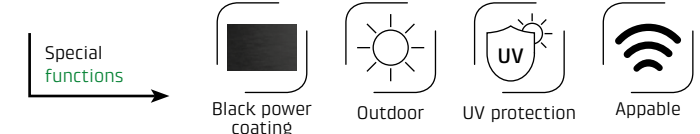

- + **Like BBQ-Deluxe Black R Smart, but with door hinge on the left**



Temperature control easily via CASO Control App



## Beer Dispenser

## BeerMaster

## Can be combined with:

- + BBQ Cooler S-R, Item 700
  - + Trolley for BBQ Cooler S-R, Item 782
  - + Drip tray, Item 687
- or
- + Counter & Cool (BBQ Cooler incl. Trolley, Item 781)
  - + Drip tray, Item 687



NEW

Heineken adapter

Item 582

Special functions

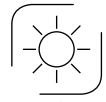

Outdoor

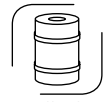

For all 5 litre beer kegs



Preserves beer for up to 10 days

- + High-quality product for fresh and cool beer
- + **Cooling system preserves beer for up to 10 days**
- + Optimum enjoyment thanks to 9 selectable temperatures (from 4 - 12 °C)
- + **Infinitely adjustable pressure for perfect beer enjoyment – as if was pulled in a pub**
- + **Suitable for all commercially available 5 litre beer kegs**, such as Krombacher, Warsteiner, Veltins, Bitburger, Heineken, etc.
- + The perfect addition to your party

- + Hygienic, easy cleaning
- + Scope of delivery:
  - Beer hose, Heineken adapter, 3 CO<sub>2</sub> pressure cartridges, Cleaning pump etc.



## Barbecue Cooler with trolley and Beer Dispenser

## TapBeer &amp; Cool

NEW

Item 583

Special functions



Outdoor



UV-Protection

## Barbecue Cooler:

- + **splash water protection (according to IPX-4)**
- + Door hinge on the right
- + **Temperature manual adjustable from 0 - 10 °C**
- + Compressor technology
- + With drip tray for the beer dispenser
- + Connectible white LED interior illumination
- + Storage volume of about 63 liters, removable shelves
- + 3-coat insulating safety glass with UV filter for optimal light protection

## Trolley:

- + Stainless steel trolley for CASO Barbecue Cooler with removable side shelves
- + **Splash water protection – Ideal for covered terraces**
- + Drawer with self-closing mechanism
- + **Side parts up to 25 kg loadable**
- + **Easily washable and very hygienic**
- + With four stable swivel castors for easy transport (front with parking brake)





## Sound &amp; Cool

## More than a lounge table



## Lounge table with soundbar and cooling compartments

## Sound &amp; Cool



Item 792



Soundbar

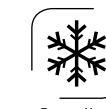

2 cooling compartments

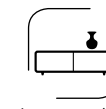

Lounge table



USB



Wireless charging

- + Lounge table with cooling compartments, integrated music speakers and charging option for smartphones etc.
- + Reliable compressor cooling
- + **Two cooling compartments (total 135 l) for snacks and drinks with individually adjustable temperature:**
  - Left cooling zone: 3 – 8 °C / 70 l volume
  - Right cooling zone: 6 – 12 °C / 65 l volume
- + The practical ECO mode ensures the temperature setting with the lowest power consumption (depending on the ambient temperature)
- + **Convenient playback of music etc. via Bluetooth 5.0**
- + Different sound programme: auto, rock, film, pop, jazz
- + With RGB LED light strip for atmospheric ambience: Individual lighting depending on the music setting
- + **Practical charging options:**
  - USB ports: 2x USB (5 V) and 1x USB-C (5 V).
  - Wireless charging for compatible smartphones (up to 15 W)
- + LED display with touch control panel
- + **High-quality tempered glass with a max. load of up to 200 kg**
- + Acoustic signal if the refrigerator compartment is open for too long
- + Versions:
  - 792: Black body with black glass top
  - 793: White body with black glass top
  - 794: Wood effect body with black glass top



Item 793



Item 794





## Dry aging cabinet

### DryAged Master 380 Pro



Item 691

freestanding  
and convertible

#### The special way to age meat

Fancy a Galician beef sirloin steak? An absolute dream for meat lovers. Thanks to its strong marbling this cut is extra tender and aromatic and can achieve its full potential in the CASO DryAged maturing cabinet.

This special way of aging meat makes it particularly tender and aromatic. Beef aged meat on the bone has been a sensation in the USA for decades now.

Dry aging is the oldest known process for maturing meat and involves aging it on the bone for a certain length of time at a controlled temperature and humidity.

CASO DryAged coolers include finely adjustable air conditioning technology and a high-quality finish. A "must-have" for meat lovers who want ultimate enjoyment.

## Dry aging cabinet

### DryAged Master 63



freestanding

## Dry aging cabinet

### DryAged Master 125

freestanding,  
can be built under  
and converted

Item 689

Item 690

Special  
Functions

Stainless steel



Sensor-Touch

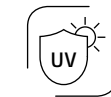

UV protection

- + High quality maturing cabinet with compressor technology
- + **For storing, presenting and maturing high quality meat**
- + DryAged Master 125 can be built under and converted, DryAged Master 380 Pro convertible
- + Usable volume:
  - 689: 63 l
  - 690: 125 l
  - 691: 380 l
- + **Temperature electronically adjustable from 2 - 14 °C (in 1 °C steps)**
- + Indoor humidity adjustable from 50 - 85 %
- + Active fans for a very even temperature
- + **Intuitive operation using the touch control panel**
- + 3-layer UV glass
- + Lockable with an integrated lock
- + Switchable interior lighting
- + **Switchable, antibacterial UV light**
- + With built-in activated carbon filter
- + Incl. Racks and hangers with meat hooks made of stainless steel + one H<sub>2</sub>O storage (two pieces for DryAged Master 380 Pro)

#### Accessories

+ Activated carbon filter, item 692



+ H<sub>2</sub>O storage (4 pieces), item 693

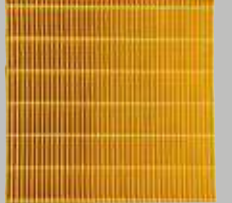

Can be ordered on [www.caso-design.de](http://www.caso-design.de)



The hook supplied with the appliance ensures that every surface of the meat matures perfectly.



The dark colouring is a classic characteristic and is removed before using the meat.



Perfectly marbled meat for an intensive taste experience.

\* The achievable value in the interior can not exceed the ambient temperature at the installation site





## CASO Design online Social Media & Websites



/casogermany



/casodesign

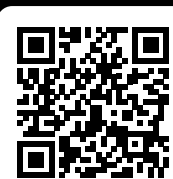

/casodesign



/casodesign



**Website:**  
[www.caso-design.com](http://www.caso-design.com)

**CASO App Portal:**  
[www.casoapp.com](http://www.casoapp.com)

**CASO Apps:**  
[www.myfoodmanager.de](http://www.myfoodmanager.de)  
[www.casocontrol.de](http://www.casocontrol.de)

## Article overview

### Wine coolers

#### Wine coolers for 1 bottle



| Product name       | VinoCase Black                  | WineCase One Inox               | WineCase One Black              | WineCase Deluxe Inox            |
|--------------------|---------------------------------|---------------------------------|---------------------------------|---------------------------------|
| Item               | 615                             | 611                             | 614                             | 616                             |
| EAN                | 40 38437 00615 5                | 40 38437 00611 7                | 40 38437 00614 8                | 40 38437 00616 2                |
| Housing / colour   | Black                           | Stainless steel                 | Black Stainless steel           | Stainless steel                 |
| Temperature range* | 5 - 18 °C                       | 5 - 18 °C                       | 5 - 18 °C                       | 5 - 18 °C                       |
| Cooling technology | Peltier                         | Peltier                         | Peltier                         | Peltier                         |
| Bottles**          | 1                               | 1                               | 1                               | 1                               |
| Operation          | Sensor-Touch                    | Sensor-Touch                    | Sensor-Touch                    | Sensor-Touch                    |
| Power              | 72 Watt                         | 72 Watt                         | 72 Watt                         | 72 Watt                         |
| Voltage            | 100 V - 240 V;<br>50 Hz / 60 Hz | 100 V - 240 V;<br>50 Hz / 60 Hz | 100 V - 240 V;<br>50 Hz / 60 Hz | 100 V - 240 V;<br>50 Hz / 60 Hz |
| Measures (WxHxD)   | 140 x 250 x<br>270 mm           | 135 x 245 x<br>285 mm           | 135 x 245 x<br>285 mm           | 135 x 245 x<br>285 mm           |
| Weight             | 1.25 kg                         | 2.4 kg                          | 2.4 kg                          | 2,4 kg                          |
| Certification      | CE, GS                          | CE, GS                          | CE, GS                          | CE, GS                          |
| Packing unit       | 1                               | 1                               | 1                               | 1                               |

#### Wine cooler



| Product name            | WineComfort 24 Black             |
|-------------------------|----------------------------------|
| Item                    | 644                              |
| EAN                     | 40 38437 00644 5                 |
| Housing / colour        | Black with stainless steel frame |
| Temperature range*      | 5 - 20 °C                        |
| Temperature zones       | 2                                |
| Cooling technology      | Compressor                       |
| Bottles**               | 24                               |
| Shelves                 | 5                                |
| Operation               | Sensor-Touch                     |
| UV filter glass         | •                                |
| Interior lighting       | LED                              |
| Energy efficiency class | G                                |
| Annual consumption      | 135 kWh/a                        |
| Power                   | 60 Watt                          |
| Voltage                 | 220 V - 240 V; 50 Hz             |
| Measures (WxHxD)        | 395 x 820 x 550 mm               |
| Weight                  | 36 kg                            |
| Certification           | CE, GS                           |
| Certification           | 1                                |

\* The achievable value in the interior can not exceed the ambient temperature at the installation site  
\*\* Bottle size based on a standard Bordeaux bottle (max. Ø 75 mm)



## Article overview

## Wine coolers

Wine coolers



| Product name  | WineComfort 240 Smart | WineComfort 380 Smart | WineComfort 660 Smart | WineComfort 1260 Smart | WineComfort 1800 Smart |
|---|-----------------------|-----------------------|-----------------------|------------------------|------------------------|
| Item  | 719                   | 720                   | 725                   | 728                    | 730                    |
| EAN   | 40 38437 00719 0      | 40 38437 00720 6      | 40 38437 00725 1      | 40 38437 00728 2       | 40 38437 00730 5       |
| Housing / colour  | Stainless steel front | Stainless steel front | Stainless steel front | Stainless steel front  | Stainless steel front  |
| Temperature range*  | 5 - 20 °C             | 5 - 20 °C             | 5 - 20 °C             | 5 - 20 °C              | 5 - 20 °C              |
| Temperature zones   | 2                     | 2                     | 2                     | 2                      | 2                      |
| Cooling technology  | Compressor            | Compressor            | Compressor            | Compressor             | Compressor             |
| Bottles**   | 24                    | 38                    | 66                    | 126                    | 180                    |
| Smart Control  | ▪                     | ▪                     | ▪                     | ▪                      | ▪                      |
| Shelves   | 6                     | 7                     | 7                     | 7                      | 8                      |
| Operation   | Sensor-Touch          | Sensor-Touch          | Sensor-Touch          | Sensor-Touch           | Sensor-Touch           |
| UV filter glass   | ▪                     | ▪                     | ▪                     | ▪                      | ▪                      |
| Interior lighting   | LED                   | LED                   | LED                   | LED                    | LED                    |
| Energy efficiency class   | G                     | G                     | G                     | G                      | G                      |
| Annual consumption  | 136 kWh/a             | 146 kWh/a             | 165 kWh/a             | 180 kWh/a              | 184 kWh/a              |
| Power   | 60 Watt               | 60 Watt               | 60 Watt               | 75 Watt                | 75 Watt                |
| Voltage   | 220 V - 240 V; 50 Hz  | 220 V - 240 V; 50 Hz  | 220 V - 240 V; 50 Hz  | 220 V - 240 V; 50 Hz   | 220 V - 240 V; 50 Hz   |
| Measures (WxHxD)  | 400 x 876 x 600 mm    | 395 x 1035 x 675 mm   | 595 x 1035 x 675 mm   | 595 x 1590 x 685 mm    | 595 x 1860 x 760 mm    |
| Weight  | 36.7 kg               | 45.9 kg               | 56.9 kg               | 76.9 kg                | 87.6 kg                |
| Certification   | CE, GS                | CE, GS                | CE, GS                | CE, GS                 | CE, GS                 |
| Packing unit  | 1                     | 1                     | 1                     | 1                      | 1                      |

\* The achievable value in the interior can not exceed the ambient temperature at the installation site  
 \*\* Bottle size based on a standard Bordeaux bottle (max. Ø 75 mm)

Wine coolers

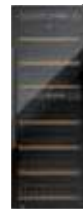

| Product name  | WineExclusive 12     | WineExclusive 24 Smart | WineExclusive 38 Smart | WineExclusive 66 Smart | WineExclusive 126 Smart | WineExclusive 180 Smart |
|---|----------------------|------------------------|------------------------|------------------------|-------------------------|-------------------------|
| Item  | 716                  | 718                    | 721                    | 726                    | 729                     | 731                     |
| EAN   | 40 38437 00716 9     | 40 38437 00718 3       | 40 38437 00721 3       | 40 38437 00726 8       | 40 38437 00729 9        | 40 38437 00731 2        |
| Housing / colour  | Black / glass front  | Black / glass front    | Black / glass front    | Black / glass front    | Black / glass front     | Black / glass front     |
| Temperature range*  | 5 - 20 °C            | 5 - 20 °C              | 5 - 20 °C              | 5 - 20 °C              | 5 - 20 °C               | 5 - 20 °C               |
| Temperature zones   | 1                    | 2                      | 2                      | 2                      | 2                       | 2                       |
| Cooling technology  | Compressor           | Compressor             | Compressor             | Compressor             | Compressor              | Kompressor              |
| Bottles**   | 12                   | 24                     | 38                     | 66                     | 126                     | 180                     |
| Smart Control  | ▪                    | ▪                      | ▪                      | ▪                      | ▪                       | ▪                       |
| Shelves   | 3                    | 6                      | 7                      | 7                      | 7                       | 8                       |
| Operation   | Sensor-Touch         | Sensor-Touch           | Sensor-Touch           | Sensor-Touch           | Sensor-Touch            | Sensor-Touch            |
| UV filter glass   | ▪                    | ▪                      | ▪                      | ▪                      | ▪                       | ▪                       |
| Interior lighting   | LED                  | LED                    | LED                    | LED                    | LED                     | LED                     |
| Energy efficiency class   | G                    | G                      | G                      | G                      | G                       | G                       |
| Annual consumption  | 130 kWh/a            | 136 kWh/a              | 146 kWh/a              | 165 kWh/a              | 180 kWh/a               | 184 kWh/a               |
| Power   | 60 Watt              | 60 Watt                | 70 Watt                | 60 Watt                | 75 Watt                 | 75 Watt                 |
| Voltage   | 220 V - 240 V; 50 Hz | 220 V - 240 V; 50 Hz   | 220 V - 240 V; 50 Hz   | 220 V - 240 V; 50 Hz   | 220 V - 240 V; 50 Hz    | 220 V - 240 V; 50 Hz    |
| Measures (WxHxD)  | 395 x 520 x 515 mm   | 400 x 876 x 585 mm     | 400 x 1035 x 685 mm    | 600 x 1035 x 685 mm    | 600 x 1590 x 685 mm     | 600 x 1860 x 750 mm     |
| Weight  | 23.95 kg             | 37 kg                  | 47.8 kg                | 60.4 kg                | 84,6 kg                 | 97 kg                   |
| Certification   | CE, GS               | CE, GS                 | CE, GS                 | CE, GS                 | CE, GS                  | CE, GS                  |
| Packing unit  | 1                    | 1                      | 1                      | 1                      | 1                       | 1                       |



## Article overview

## Wine coolers

Wine coolers



| Product name   | WineChef Pro 40                     | WineChef Pro 126             | WineChef Pro 126-2D          | WineChef Pro 180             |
|--|-------------------------------------|------------------------------|------------------------------|------------------------------|
| Item   | 772                                 | 775                          | 776                          | 779                          |
| EAN  | 40 38437 00772 5                    | 40 38437 00775 6             | 40 38437 00776 3             | 40 38437 00779 4             |
| Housing / colour   | Stainless steel front               | Stainless steel front        | Stainless steel front        | Stainless steel front        |
| Temperature range*   | 5 - 20 °C                           | 5 - 20 °C                    | 5 - 20 °C                    | 5 - 20 °C                    |
| Temperature zones  | 2                                   | 2                            | 2 + 2 doors                  | 2                            |
| Cooling technology   | Compressor                          | Compressor                   | Compressor                   | Compressor                   |
| Bottles**  | 40                                  | 126                          | 126                          | 180                          |
| Kind of use  | Free-standing or can be built under | Free-standing or convertible | Free-standing or convertible | Free-standing or convertible |
| Smart Control  | ▪                                   | ▪                            | ▪                            | ▪                            |
| Shelves  | 5                                   | 7                            | 7                            | 7                            |
| Operation  | Sensor-Touch                        | Sensor-Touch                 | Sensor-Touch                 | Sensor-Touch                 |
| UV filter glass  | ▪                                   | ▪                            | ▪                            | ▪                            |
| Interior lighting  | LED                                 | LED                          | LED                          | LED                          |
| Energy efficiency class  | G                                   | G                            | G                            | G                            |
| Annual consumption   | 142 kWh/a                           | 166 kWh/a                    | 166 kWh/a                    | 175 kWh/a                    |
| Power  | 70 Watt                             | 55 Watt                      | 55 Watt                      | 55 Watt                      |
| Voltage  | 220 V - 240 V; 50 Hz                | 220 V - 240 V; 50 Hz         | 220 V - 240 V; 50 Hz         | 220 V - 240 V; 50 Hz         |
| Measures (WxHxD)   | 595 x 825 x 625 mm                  | 595 x 1630 x 740 mm          | 595 x 1630 x 740 mm          | 595 x 1860 x 740 mm          |
| Weight   | 48.5 kg                             | 101 kg                       | 97.8 kg                      | 107 kg                       |
| Certification  | CE, GS                              | CE, GS                       | CE, GS                       | CE, GS                       |
| Packing unit   | 1                                   | 1                            | 1                            | 1                            |

Wine coolers

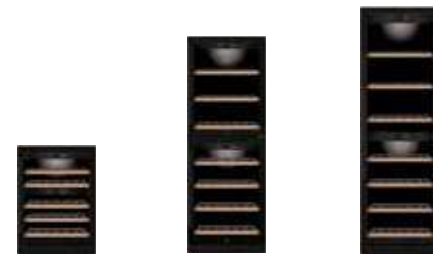

| Product name  | WineChef Pro 40 Black               | WineChef Pro 126-2D Black    | WineChef Pro 180 Black       |
|---|-------------------------------------|------------------------------|------------------------------|
| Item  | 773                                 | 777                          | 780                          |
| EAN   | 40 38437 00773 2                    | 40 38437 00777 0             | 40 38437 00780 0             |
| Housing / colour  | Black stainless steel front         | Black stainless steel front  | Black stainless steel front  |
| Temperature range*  | 5 - 20 °C                           | 5 - 20 °C                    | 5 - 20 °C                    |
| Temperature zones   | 2                                   | 2 + 2 doors                  | 2                            |
| Cooling technology  | Compressor                          | Compressor                   | Compressor                   |
| Bottles**   | 40                                  | 126                          | 180                          |
| Kind of use   | Free-standing or can be built under | Free-standing or convertible | Free-standing or convertible |
| Smart Control  | ▪                                   | ▪                            | ▪                            |
| Shelves   | 5                                   | 7                            | 7                            |
| Operation   | Sensor-Touch                        | Sensor-Touch                 | Sensor-Touch                 |
| UV filter glass   | ▪                                   | ▪                            | ▪                            |
| Interior lighting   | LED                                 | LED                          | LED                          |
| Energy efficiency class   | G                                   | G                            | G                            |
| Annual consumption  | 142 kWh/a                           | 166 kWh/a                    | 175 kWh/a                    |
| Power   | 70 Watt                             | 75 Watt                      | 75 Watt                      |
| Voltage   | 220 V - 240 V; 50 Hz                | 220 V - 240 V; 50 Hz         | 220 V - 240 V; 50 Hz         |
| Measures (WxHxD)  | 595 x 825 x 640 mm                  | 595 x 1630 x 740 mm          | 595 x 1860 x 740 mm          |
| Weight  | 52.5 kg                             | 104 kg                       | 107.75 kg                    |
| Certification   | CE, GS                              | CE, GS                       | CE, GS                       |
| Packing unit  | 1                                   | 1                            | 1                            |

Built-in wine coolers



| Product name            | WineSafe 18 EB Black | WineSafe 18 EB Inox   |
|-------------------------|----------------------|-----------------------|
| Item                    | 627                  | 629                   |
| EAN                     | 40 38437 00627 8     | 40 38437 00629 2      |
| Housing / colour        | Glas front           | Stainless steel frame |
| Niche height            | 45er                 | 45er                  |
| Temperature range*      | 5 - 20 °C            | 5 - 20 °C             |
| Temperature zones       | 1                    | 1                     |
| Cooling technology      | Compressor           | Compressor            |
| Bottles**               | 18                   | 18                    |
| Shelves                 | 3                    | 3                     |
| Operation               | Sensor-Touch         | Sensor-Touch          |
| UV filter glass         | ▪                    | ▪                     |
| Interior lighting       | LED                  | LED                   |
| Energy efficiency class | G                    | G                     |
| Annual consumption      | 128 kWh/a            | 128 kWh/a             |
| Power                   | 60 Watt              | 60 Watt               |
| Voltage                 | 220 V - 240 V; 50 Hz | 220 V - 240 V; 50 Hz  |
| Measures (WxHxD)        | 590 x 455 x 575 mm   | 590 x 455 x 575 mm    |
| Weight                  | 28.3 kg              | 28.5 kg               |
| Certification           | CE, GS               | CE, GS                |
| Packing unit            | 1                    | 1                     |

Wine coolers



| Product name  | WineSafe 300 Smart   | WineChef Duo 122 Black       |
|---|----------------------|------------------------------|
| Item  | 664                  | 674                          |
| EAN   | 40 38437 00664 3     | 40 38437 00674 2             |
| Housing / colour  | Black                | Black                        |
| Temperature range*  | 5 - 20 °C            | 5 - 20 °C / 2-20 °C          |
| Temperature zones   | 1                    | 2                            |
| Cooling technology  | Compressor           | Compressor                   |
| Bottles**   | 300                  | 122                          |
| Kind of use   |                      | Free-standing or convertible |
| Smart Control  | ▪                    |                              |
| Shelves   | 11                   | 13 left, 4 right             |
| Operation   | Sensor-Touch         | Sensor-Touch                 |
| UV filter glass   | ▪                    | ▪                            |
| Interior lighting   | LED                  | LED                          |
| Energy efficiency class   | G                    | G                            |
| Annual consumption  | 209 kWh/a            | 173 kWh/a                    |
| Power   | 200 Watt             | 160 Watt                     |
| Voltage   | 220 V - 240 V; 50 Hz | 220 V - 240 V; 50 Hz         |
| Measures (WxHxD)  | 805 x 204,5 x 800 mm | 550 x 890 x 1627 mm          |
| Weight  | 168 kg               | 108 kg                       |
| Certification   | CE, GS               | CE, GS                       |
| Packing unit  | 1                    | 1                            |

\* The achievable value in the interior can not exceed the ambient temperature at the installation site

\*\* Bottle size based on a standard Bordeaux bottle (max. Ø 75 mm)



## Article overview

## Barbecue Cooler

Barbecue Cooler



| Product name  | BBQ-Cooler S-R       | BBQ-Cooler S-L       | BBQ-Cooler Black S-R  | BBQ-Cooler Black S-L  | BBQ Cooler M-R       | BBQ Cooler M-L       | BBQ-Deluxe R Smart    | BBQ-Deluxe L Smart    | BBQ-Deluxe Black R Smart | BBQ-Deluxe Black L Smart | Steel trolley (without cooler)                                     |
|---|----------------------|----------------------|-----------------------|-----------------------|----------------------|----------------------|-----------------------|-----------------------|--------------------------|--------------------------|--|
| Item  | 700                  | 701                  | 702                   | 703                   | 696                  | 697                  | 707                   | 708                   | 709                      | 710                      | 782  |
| EAN   | 40 38437 00700 8     | 40 38437 00701 5     | 40 38437 00702 2      | 40 38437 00703 9      | 40 38437 00696 4     | 40 38437 00697 1     | 40 38437 00707 7      | 40 38437 00708 4      | 40 38437 00709 1         | 40 38437 00710 7         | 40 38437 00782 4   |
| Housing / colour  | Stainless steel      | Stainless steel      | Stainless steel black | Stainless steel black | Stainless steel      | Stainless steel      | Stainless steel       | Stainless steel       | Black power coating      | Black power coating      | Stainless steel  |
| Door hinge  | On the right         | On the left          | On the right          | On the left           | On the right         | On the right         | On the right          | On the left           | On the right             | On the left              |  |
| Temperature range*  | -1 - 10 °C           | -1 - 10 °C           | -1 - 10 °C            | -1 - 10 °C            | -1 - 10 °C           | -1 - 10 °C           | -1 - 10 °C            | -1 - 10 °C            | -1 - 10 °C               | -1 - 10 °C               |  |
| Temperature zones   | 1                    | 1                    | 1                     | 1                     | 1                    | 1                    | 1                     | 1                     | 1                        | 1                        |  |
| Cooling technology  | Compressor           | Compressor           | Compressor            | Compressor            | Compressor           | Compressor           | Compressor            | Compressor            | Compressor               | Compressor               |  |
| Smart Control  |                      |                      |                       |                       |                      |                      | ▪                     | ▪                     | ▪                        | ▪                        |  |
| Storage capacity  | 63 l                 | 63 l                 | 63 l                  | 63 l                  | 125 l                | 190 l                | 63 l                  | 63 l                  | 63 l                     | 63 l                     |  |
| Shelves   | 4                    | 4                    | 4                     | 4                     | 4                    | 4                    | 4                     | 4                     | 4                        | 4                        | Can be combined with other BBQ-Coolers: Item 700, 701, 702 and 703 |
| Operation   |                      |                      |                       |                       |                      |                      | Digital-Touch-Display | Digital-Touch-Display | Digital-Touch-Display    | Digital-Touch-Display    |  |
| IPX-4 (splash water protection)   | ▪                    | ▪                    | ▪                     | ▪                     | ▪                    | ▪                    | ▪                     | ▪                     | ▪                        | ▪                        |  |
| UV filter glass   | ▪                    | ▪                    | ▪                     | ▪                     | ▪                    | ▪                    | ▪                     | ▪                     | ▪                        | ▪                        |  |
| Interior lighting   | LED                  | LED                  | LED                   | LED                   | LED                  | LED                  | LED                   | LED                   | LED                      | LED                      |  |
| Energy efficiency class   | A                    | A                    | A                     | A                     | B                    | B                    | A                     | A                     | A                        | A                        |  |
| Annual consumption  | 345 kWh/a            | 345 kWh/a            | 345 kWh/a             | 345 kWh/a             | 584 kWh/a            | 657 kWh/a            |                       |                       |                          |                          |  |
| Power   | 0.4 A                | 0.4 A                | 0.4 A                 | 0.4 A                 | 0.6 A                | 0.6 A                | 0,4 A                 | 0,4 A                 | 0,4 A                    | 0,4 A                    |  |
| Voltage   | 220 V - 240 V; 50 Hz | 220 V - 240 V; 50 Hz | 220 V - 240 V; 50 Hz  | 220 V - 240 V; 50 Hz  | 220 V - 240 V; 50 Hz | 220 V - 240 V; 50 Hz | 220 V - 240 V; 50 Hz  | 220 V - 240 V; 50 Hz  | 220 V - 240 V; 50 Hz     | 220 V - 240 V; 50 Hz     |  |
| Measures (WxHxD)  | 430 x 675 x 555 mm   | 430 x 675 x 555 mm   | 430 x 680 x 550 mm    | 430 x 680 x 550 mm    | 395 x 1025 x 650 mm  | 595 x 1025 x 650 mm  | 430 x 688 x 510 mm    | 430 x 688 x 510 mm    | 430 x 688 x 510 mm       | 430 x 688 x 510 mm       | 1010 x 985 x 600 mm  |
| Weight  | 32.1 kg              | 32.1 kg              | 35.15 kg              | 35.15 kg              | 44.1 kg              | 59.5 kg              |                       |                       |                          |                          | 27.8 kg  |
| Certification   | CE, GS               | CE, GS               | CE, GS                | CE, GS                | CE, GS               | CE, GS               | CE, GS                | CE, GS                | CE, GS                   | CE, GS                   |  |
| Packing unit  | 1                    | 1                    | 1                     | 1                     | 1                    | 1                    | 1                     | 1                     | 1                        | 1                        | 1  |

\* The achievable value in the interior can not exceed the ambient temperature at the installation site



## Article overview

## Beer Dispenser / Lounge tables

## Beer Dispenser



| Product name                    | BeerMaster   | TapBeer & Cool   |
|---------------------------------|--|--|
| Item                            | 582  | 583  |
| EAN                             | 40 38437 00582 0   | 40 38437 00583 7   |
| Housing / colour                | Stainless steel / black  | Stainless steel / black  |
| Door hinge                      |  | On the right   |
| Temperature range*              | 4 - 12 °C  | Beer Dispenser: 4 - 12 °C / BBQ Cooler: -1 - 10 °C                                     |
| Temperature zones               |  | 1  |
| Cooling technology              | Peltier  | Compressor   |
| Storage capacity                |  | BBQ Cooler: 63 l   |
| Shelves                         |  | 4  |
| IPX-4 (splash water protection) |  | ▪  |
| UV filter glass                 |  | ▪  |
| Interior lighting               |  | ▪  |
| Energy efficiency class         |  | G  |
| Annual consumption              |  | 99 kWh/a   |
| Accessories                     | Beer hose, Heineken adapter, 3 CO <sub>2</sub> pressure cartridges, Cleaning pump etc. | Beer hose, Heineken adapter, 3 CO <sub>2</sub> pressure cartridges, Cleaning pump etc. |
| Power                           | 65 Watt  | Beer Dispenser: 65 Watt / BBQ Cooler: 60 Watt  |
| Voltage                         | 220-240V; 50Hz   | Beer Dispenser: 220-240V; 50Hz / BBQ Cooler: 230 V / 50 Hz                             |
| Measures (WxHxD)                | 280 x 475 x 480 mm   | Beer Dispenser: 280 x 475 x 480 mm<br>BBQ Cooler: 430 x 690 x 540 mm                   |
| Weight                          | 5.4 kg   | Beer Dispenser: 5.4 kg / BBQ Cooler: 31.4 kg   |
| Certification                   | CE, GS   | CE, GS   |
| Packing unit                    | 1  | 1  |

## Lounge tables with sound bar and cooling compartments



| Product name              | Sound & Cool Black   | Sound & Cool White   | Sound & Cool Wood  |
|---------------------------|--|--|--|
| Item                      | 792  | 793  | 794  |
| EAN                       | 40 38437 00792 3   | 40 38437 00793 0   | 40 38437 00794 7   |
| Housing / colour          | Black housing with black glass top                           | White housing with black glass top                           | Wood-look housing with black glass top                       |
| Temperature range*        | Left cooling zone: 3 - 8 °C<br>Right cooling zone: 6 - 12 °C | Left cooling zone: 3 - 8 °C<br>Right cooling zone: 6 - 12 °C | Left cooling zone: 3 - 8 °C<br>Right cooling zone: 6 - 12 °C |
| Temperature zones         | 2  | 2  | 2  |
| Cooling technology        | Compressor   | Compressor   | Compressor   |
| Storage volume            | Left cooling zone: 70 l<br>Right cooling zone: 65 l          | Left cooling zone: 70 l<br>Right cooling zone: 65 l          | Left cooling zone: 70 l<br>Right cooling zone: 65 l          |
| Operation                 | Touch  | Touch  | Touch  |
| Load capacity glass plate | Up to 200 kg   | Up to 200 kg   | Up to 200 kg   |
| Sound programs            | Auto, Rock, Film, Pop, Jazz                                  | Auto, Rock, Film, Pop, Jazz                                  | Auto, Rock, Film, Pop, Jazz                                  |
| RGB light bar             | ▪  | ▪  | ▪  |
| Energy efficiency class   | F  | F  | F  |
| Annual consumption        | 91 kWh/a   | 91 kWh/a   | 91 kWh/a   |
| Power                     | 0.7 A  | 0.7 A  | 0.7 A  |
| Voltage                   | 220 V - 240 V; 50/60 Hz                                      | 220 V - 240 V; 50/60 Hz                                      | 220 V - 240 V; 50/60 Hz                                      |
| Measures (WxHxD)          | 1305 x 460 x 700 mm  | 1305 x 460 x 700 mm  | 1305 x 460 x 700 mm  |
| Weight                    | 55.3 kg  | 55.3 kg  | 55.3 kg  |
| Certification             | CE   | CE   | CE   |
| Packing unit              | 1  | 1  | 1  |

\* The achievable value in the interior cannot exceed the ambient temperature at the installation site

## Article overview

## Dry aged coolers

## Dry-Aged Cooler



| Product name       | DryAged Master 63  | DryAged Master 125   | DryAged Master 380 Pro                                       |
|--------------------|--|--|--|
| Item               | 689  | 690  | 691  |
| EAN                | 40 38437 00689 6   | 40 38437 00690 2   | 40 38437 00691 9   |
| Housing / colour   | Stainless steel front  | Stainless steel front  | Stainless steel front  |
| Temperature range* | 2 - 14 °C  | 2 - 14 °C  | 2 - 14 °C  |
| Temperature zones  | 1  | 1  | 1  |
| Cooling technology | Compressor   | Compressor   | Compressor   |
| Volume             | 63 Liter   | 125 Liter  | 380 Liter  |
| Operation          | Sensor-touch   | Sensor-touch   | Sensor-touch   |
| UV filter glass    | ▪  | ▪  | ▪  |
| Interior lighting  | ▪  | ▪  | ▪  |
| Annual consumption | 190 kWh/a  | 200 kWh/a  | 290 kWh/a  |
| Accessories        | 4 racks, hangers with 3 meat hooks, H <sub>2</sub> O storage | 4 racks, hangers with 3 meat hooks, H <sub>2</sub> O storage | 4 racks, hangers with 6 meat hooks, H <sub>2</sub> O storage |
| Power              | 0,4 A  | 140 Watt   | 240 Watt   |
| Voltage            | 220 V - 240 V; 50 Hz   | 220 V - 240 V; 50 Hz   | 220 V - 240 V; 50 Hz   |
| Measures (WxHxD)   | 395 x 875 x 595 mm   | 595 x 825 x 640 mm   | 595 x 1860 x 740 mm  |
| Weight             | 41.4 kg  | 57.4 kg  | 104.2 kg   |
| Certification      | CE, GS   | CE, GS   | CE, GS   |
| Packing unit       | 1  | 1  | 1  |





CASO®

D E S I G N

INNOVATIVE KITCHEN TECHNOLOGY



Competence book



Competence book kitchen



**SCAN ME**  
You can find all  
catalogues here

## Germany

---

### **CASO Design**

CASO GmbH  
Raiffeisenstraße 9  
59757 Arnsberg, Germany

fon +49 (0) 29 32 . 547 66 0  
fax +49 (0) 29 32 . 547 66 77  
info@caso-design.de

[www.caso-design.de](http://www.caso-design.de)

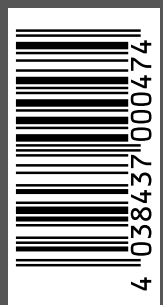

Subject to change, colour variation and printing errors. Copyright by CASO GmbH // Layout: CASO GmbH // Pictorial sources: www.foto-stroll.de, www.tooldesign.de, www.stock.adobe.com, www.unsplash.com and CASO GmbH. For writing efficiency reasons, the male gender is usually used to designate groups of people. This is in no way meant to constitute any discrimination of or prejudice against the female and diverse genders, but is mainly meant to ensure that it is not unnecessarily difficult to read a text. Printed in Germany V1\_2025.