

DORN  
BRACHT

# YOUR SPACE

Kitchen



Leading Designs for Architecture

# OF LIFE



EXPERIENCE OUR KITCHEN SERIES MEM  
ON PAGE 70 →



**EN** “Your Space of Life” – that’s exactly what the kitchen is. An entirely personal space, where everyone has unique demands and expectations. Fulfilling these in the best possible way is our highest priority. When you choose Dornbracht products, you are choosing exceptional quality, craftsmanship and sustainable manufacturing “Made in Iserlohn.” You are also choosing maximum individuality: we guarantee this not only with our characteristic design series, but also with our wide range of finishes, product features and accessories. When all these details are perfectly coordinated, it’s what makes a kitchen ‘your’ kitchen.

On the following pages, we will celebrate the kitchen as a living space and a focal point, true to our promise of “Leading Designs for Architecture.” With interiors and architectures that set progressive impulses; that are designed to inspire you and delight the senses. And with well thought-out, aesthetically sustainable products that genuinely enrich your life in the kitchen for a long time to come.

**FR** « Your Space of Life » – c’est exactement ce qu’est la cuisine. Un lieu très personnel, auquel chacun pose ses propres exigences. Notre principale ambition est de les satisfaire au mieux. Opter pour Dornbracht, c’est donc toujours opter pour une qualité exceptionnelle, pour l’artisanat d’art et la fabrication durable « Made in Iserlohn ». Mais aussi pour une individualité maximale : nous le garantissons non seulement avec nos séries design caractéristiques, mais aussi avec le large choix de finitions, de fonctionnalités et d’accessoires. Car ce sont justement ces détails qui, parfaitement adaptés les uns aux autres, font d’une cuisine « votre » cuisine.

Dans les pages suivantes, nous célébrons la cuisine en tant qu’espace de vie central – parfaitement dans l’esprit de notre promesse « Leading Designs for Architecture » : avec des intérieurs et des architectures qui insufflent un élan avant-gardiste, dont le but est de vous inspirer et de vous enthousiasmer. Et avec des produits bien pensés, à l’esthétique durable, qui enrichissent réellement et durablement votre vie dans la cuisine.

**ES** “Your space of Life”, esto es exactamente la cocina. Un lugar totalmente personal para el que cada cual tiene sus propios deseos. Colmarlos de la mejor manera posible es nuestra mayor aspiración. Por ello, elegir Dornbracht asegura siempre una calidad excepcional, trabajo artesanal y fabricación sostenible “made in Iserlohn”. Y también la máxima individualización: esto no solo lo garantizamos con nuestras series de diseño características, sino también con la gran variedad de acabados, funciones y complementos. Y es que, en una armonía perfecta, son precisamente esos detalles los que convierten una cocina en “su” cocina.

En las próximas páginas celebramos la cocina como espacio de vida protagonista, siguiendo nuestro lema “Leading Designs for Architecture”: con interiores y arquitecturas que constituyen impulsos vanguardistas, que pretenden inspirarle y entusiasmarle. Y con productos ingeniosos y de larga vida estética que enriquecen de verdad su vida en la cocina

Stefan Gesing CEO Dornbracht

# KITCHEN

009	Design Principles Design Principles Principios de diseño
015	Functional Highlights Approfondimenti funzionali Funcionalidad destacada
029	Finishes Finiture Acabados
035	Accessories Accessori Complementos
041	Your Space of Life

# CONTENTS

Design Collections	045
VAIA	048
MEM	066
META SQUARE	082
TARA	098
TARA ULTRA	114
LOT	132
SYNC	148
ELIO	164
ENO	180
x-tra Service	197
Sustainability Sostenibilità Sostenibilidad	201

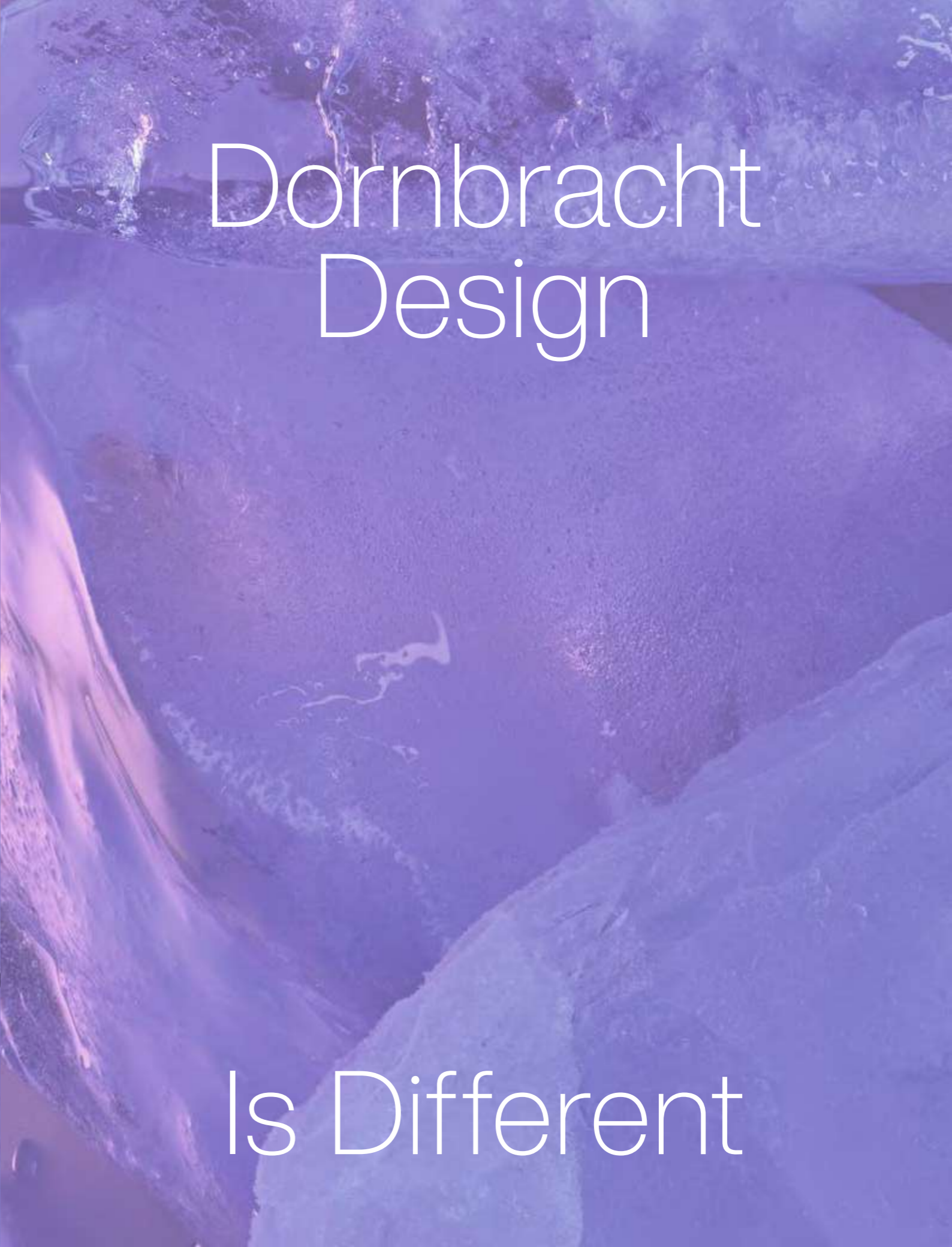

Dornbracht  
Design

Is Different

<sup>EN</sup> Dornbracht always strives for uniqueness and excellence. To ensure this high standard, our products are based on five design principles.

<sup>FR</sup> Dornbracht aspire toujours à l'unicité et à l'excellence. Pour garantir cette exigence élevée, nos développements reposent sur cinq principes de design.

<sup>ES</sup> Dornbracht persigue siempre el carácter único y la excelencia: para garantizarlos, nuestros desarrollos se basan en cinco principios de diseño.

## The Design Principles – Striving for Excellence



1 PROPORTION



2 PRECISION

4 PERFORMANCE



3 PROGRESSIVENESS

5 PERSONALITY



## 1 PROPORTION

**EN** Dornbracht fittings have perfect proportions. Their design follows a timeless ideal – perfectly balanced, harmonious, and precise. This perfection is the essence of their iconic and enduring aesthetics.

**FR** Les robinetteries Dornbracht ont des proportions parfaites. Leur design suit un idéal intemporel – équilibré, harmonieux et précis. Cette perfection est à l'origine de leur esthétique emblématique et durable.

**ES** Las griferías Dornbracht presentan proporciones perfectas. Su diseño sigue un ideal atemporal: equilibrado, armonioso y exacto. Esta perfección explica su estética icónica y duradera.

## 2 PRECISION

**EN** Dornbracht fittings stand for precision without compromise. Clear lines and precise radii characterize their design, while first-class finishes and the highest manufacturing quality characterize their workmanship. The care with which even the smallest details are handled is unrivaled.

**FR** Les robinetteries Dornbracht sont synonymes de précision sans compromis. Des lignes claires et des rayons précis caractérisent leur forme et des surfaces et une qualité artisanale haut de gamme leur finition. Le soin avec lequel les moindres détails sont réalisés est inégalé.

**ES** Las griferías Dornbracht son sinónimo de precisión incondicional. Líneas claras y radios exactos caracterizan su forma, acabados de primera y la máxima calidad de manufactura. El mimo con el que se plasman incluso los más ínfimos detalles no tiene par.

## 3 PROGRESSIVENESS

**EN** Dornbracht fittings are progressive and forward-thinking. They represent a forward-thinking logic and mindset that is open to new ideas. They provide inspiration for architectural and interior designs with visionary aspirations. In constant dialogue with the zeitgeist, they set standards for the present and the future.

**FR** Avec leur design avant-gardiste, les robinetteries Dornbracht adoptent une attitude progressiste et ouverte à la nouveauté. Elles sont une source d'inspiration pour les architectures et les designs d'intérieur aux ambitions visionnaires. Toujours dans l'air du temps, elles posent des jalons pour le présent et l'avenir.

**ES** Los productos Dornbracht son progresivos. Siguen un patrón vanguardista y abierto a lo nuevo, e inspiran a arquitecturas y diseños de interiores con su pretensión visionaria. En un diálogo constante con los referentes actuales, crean nuevos espacios para el presente y el futuro.

## 4 PERFORMANCE

**EN** Dornbracht fittings stand for excellent performance. While fulfilling the highest demands in terms of functionality, Dornbracht fittings direct one's focus to diverse forms of water presentation. In this way, a unique experience with water enriches your daily life.

**FR** Les robinetteries Dornbracht sont synonymes d'excellence. Les exigences les plus élevées en matière de fonction et d'utilisation mettent l'accent sur les multiples formes de présentation de l'eau. Elles créent ainsi des expériences de l'eau uniques et des valeurs ajoutées enrichissantes.

**ES** Las griferías Dornbracht son sinónimo de excelencia. Las más altas exigencias de funcionalidad y uso se centran en las variadas formas de hacer fluir al agua. Esto da lugar a experiencias acuáticas únicas y a valores añadidos que enriquecen nuestras vidas.

## 5 PERSONALITY

**EN** Dornbracht fittings have distinct characteristics and personality. They consistently embody an independent spirit that makes a unique statement, with their unmistakable presence arising from an interplay of striking design and expressive finishes.

**FR** Les robinetteries Dornbracht ne manquent pas d'originalité et de personnalité. Elles incarnent toujours un caractère unique et se distinguent par un style individuel et affirmé. Leur identité propre résulte de l'interaction entre une forme distinctive et des surfaces expressives.

**ES** Las griferías Dornbracht son piezas genuinas con personalidad. Reflejan siempre un carácter propio, creando así individualidad y genuinidad. Su identidad inconfundible se deriva de la fusión de formas llamativas y acabados de gran expresividad.



Find out more:  
[dornbracht.com/design-principles](https://dornbracht.com/design-principles)



Functional Highlights



Elegant  
and Efficient

PULL-DOWN WITH LAMINAR FLOW  
DISCOVER MORE ON PAGE 162 →





<sup>EN</sup> PULL-DOWN and PULL-OUT fittings make daily activities in the kitchen more comfortable and convenient. The pull-out element can be pulled out downwards or forwards. Different sprays and streams are possible, depending on the product model: shower spray, laminar stream, or aerated stream.

<sup>FR</sup> Les robinetteries PULL-DOWN et PULL-OUT rendent les gestes quotidiens dans la cuisine plus confortables. L'élément extractible peut être retiré vers le bas ou vers l'avant. Différents types de jets sont possibles, selon le modèle de produit : jet douchette et jet laminaire ou jet enrichi en air.

<sup>ES</sup> Las griferías PULL-DOWN y PULL-OUT logran que los movimientos cotidianos en la cocina resulten más cómodos. El elemento final puede ser extraído hacia abajo o hacia delante. Dependiendo del modelo de producto, existen diferentes tipos de chorro disponibles: chorro concentrado, laminar o enriquecido con aire.

## PULL-OUT Function & PULL-DOWN Function



**EN** Exceptionally practical: The flexible pull-out element offers an extended range of action in the kitchen.

**FR** Très pratique : l'élément extractible flexible offre un rayon d'action étendu dans la cuisine.

**ES** Especialmente práctico: el elemento extraíble flexible permite disfrutar de un mayor radio de acción en la cocina.



## Professional Use

**EN** Inspired by professional kitchens: our professional fittings and side sprayers combine excellent design with ultimate functionality. They provide thorough and precise assistance with everyday tasks at the water point.

**FR** Inspirées par les cuisines professionnelles : nos robinetteries Profi et nos douchettes pendulaires latérales allient un design exceptionnel à une fonctionnalité maximale. Elles vous aident à effectuer les tâches quotidiennes au point d'eau avec minutie et précision.

**ES** Inspirado en cocinas profesionales: nuestras griferías Profi y los grifos Profi laterales conjugan un magnífico diseño con la máxima funcionalidad. Y nos respaldan de forma precisa y exacta en los movimientos cotidianos de la zona del fregadero.



TARA ULTRA PROFI WITH  
SPRAY FLOW AND AIR-ENRICHED FLOW  
DISCOVER MORE ON PAGE 124 →

## POT FILLER &amp; PIVOT



**EN** Perfect Twist: PIVOT and POT FILLER have a swivel spout that can be rotated flexibly in all directions. They make filling pots and vessels possible directly next to the stove.

**FR** Torsion parfaite : les robinetteries PIVOT et POT FILLER disposent d'un bec orientable dans tous les sens. Les casseroles et les récipients peuvent ainsi être remplis directement sur le plan de cuisson.

**ES** Giro perfecto: PIVOT y POT FILLER disponen de un caño de salida giratorio que puede girarse en todas las direcciones. De este modo, es posible llenar ollas y recipientes directamente en la placa de cocina.



A PLACE FOR MEETING OTHERS AND ENJOYING CULINARY EXPERIENCES - ACTS OF EATING AND COOKING TOGETHER - TRACES OF ENCOUNTER. THE ARCHITECTURE OF COOKING BASED ON ACTION AND MEMORIES. YOUR SPACE OF LIFE. A PLACE FOR MEETING OTHERS AND ENJOYING CULINARY EXPERIENCES

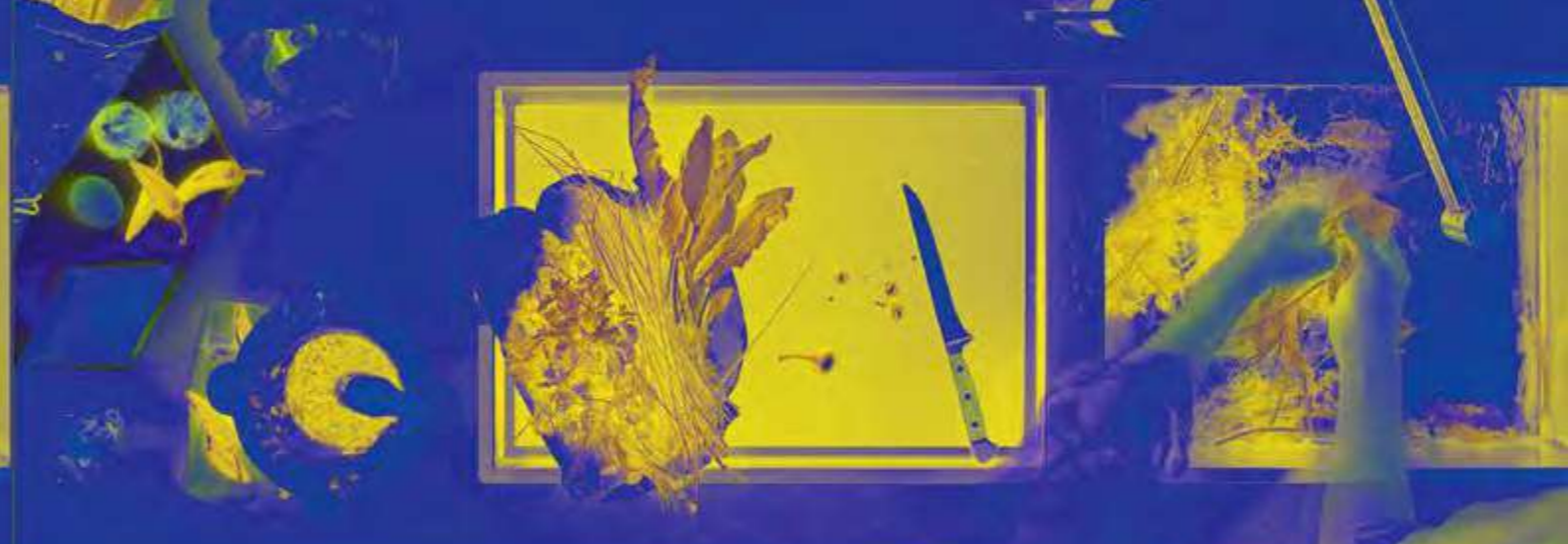



Finishes

Perfection in  
Every Dimension



Brushed Durabrass (23kt Gold)



<sup>EN</sup> Dornbracht considers finishes to be a completely independent design element. The combination of superior technological and design expertise enables Dornbracht to consistently set exceptional standards.

<sup>FR</sup> Dornbracht considère les finitions comme une dimension de conception à part entière. Grâce à son expertise technologique combinée à sa haute compétence en matière de design, Dornbracht définit sans cesse des standards exceptionnels.

<sup>ES</sup> Dornbracht considera los acabados como una dimensión de configuración independiente. Esta combinación de experiencia tecnológica y alta competencia de diseño permite a Dornbracht crear regularmente referentes extraordinarios.





Dark Chrome

<sup>EN</sup> Dornbracht offers a wide variety of curated finishes to suit your individual needs and style.

<sup>FR</sup> Pour répondre à vos besoins individuels et à votre style, Dornbracht propose une grande variété de finitions sélectionnées.

<sup>ES</sup> Para sus necesidades y su estilo personales, Dornbracht ofrece una amplia gama de acabados seleccionados.



Durabronze (23kt Gold)  
Brushed Durabronze (23kt Gold)



Accessories



Make it Match



**EN** Everything from a single source and perfectly combinable: Dornbracht has practical dishwashing detergent dispensers and other accessories for your kitchen, such as the eccentric actuator with rotary knob or the side sprayer.

**FR** Des produits disponibles auprès d'un seul fournisseur et parfaitement combinables : pour votre cuisine, Dornbracht tient à votre disposition des distributeurs de produit vaisselle pratiques et d'autres accessoires, comme la commande de vidage individuelle manuelle ou la douchette extractible latérale.

**ES** Todo a mano, y combinable a la perfección: para su cocina, Dornbracht dispone de prácticos dispensadores de detergente y más complementos, como por ejemplo el accionamiento exéntrico con selector giratorio o el juego de ducha lateral.





Your Space

of Life

<sup>EN</sup> The kitchen: a focal point and a space full of emotion – where functionality meets aesthetics and sophisticated taste.

<sup>FR</sup> La cuisine : le centre de la vie et une pièce pleine d'émotions où la fonctionnalité s'allie à l'esthétique et l'exigence au goût.

<sup>ES</sup> La cocina: el centro de la vida y un espacio lleno de emociones, en el que la funcionalidad, la estética y la exigencia se conjugan con el buen gusto.



More Than Just a Place to Cook

Divine Chaos

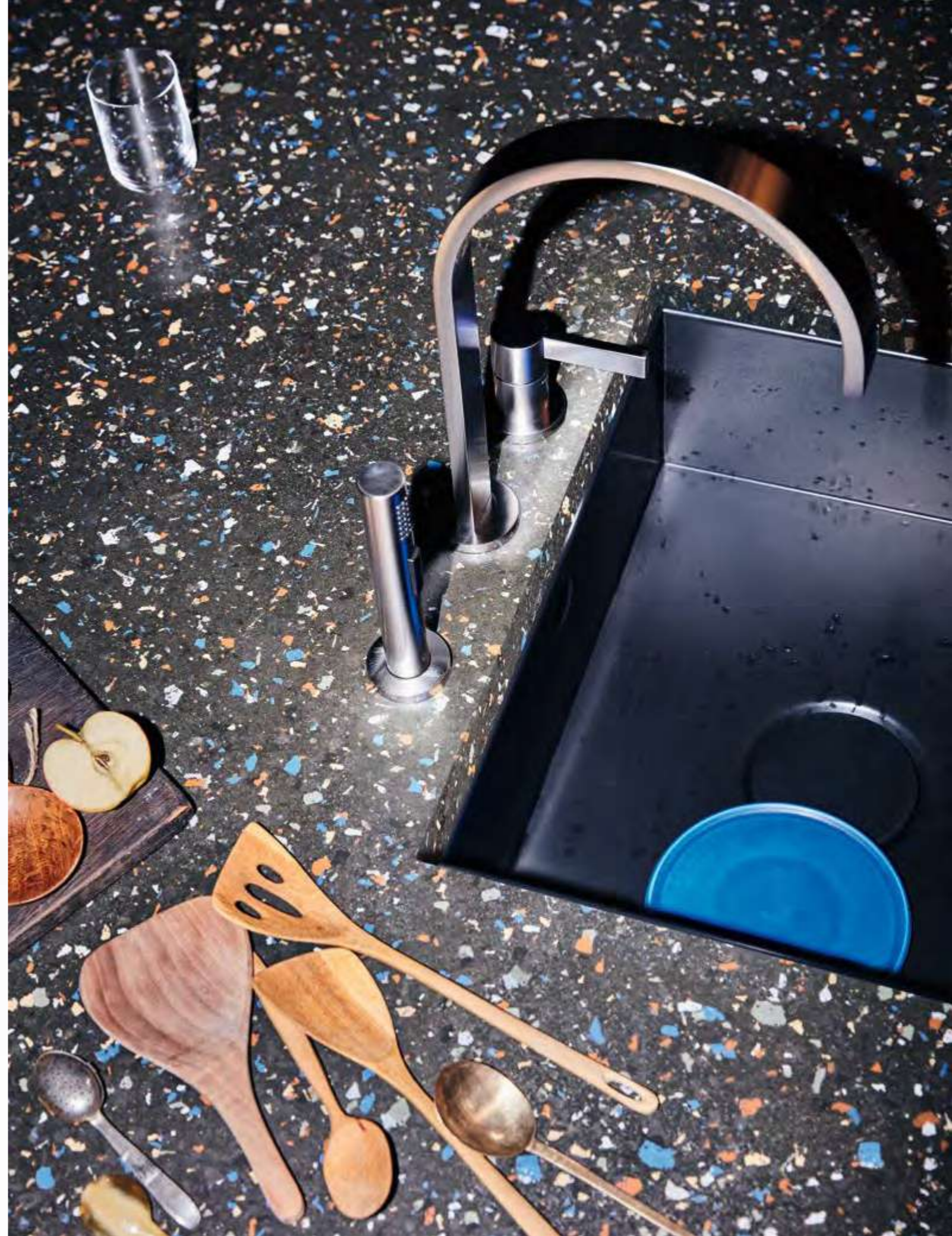



Design  
THE  
PERFECT  
MATCH

FOR YOUR  
KITCHEN  
Collections



VAIA



TARA ULTRA



MEM



META SQUARE



TARA



LOT



SYNC



ELIO



ENO

- 048 VAIA
- 066 MEM
- 082 META SQUARE
- 098 TARA
- 114 TARA ULTRA
- 132 LOT
- 148 SYNC
- 164 ELIO
- 180 ENO



# VAIA





EN VAIA unites tradition and modernity. Its graceful design language, with filigree lines and an open silhouette, creates a balance between the familiar and the new.

FR VAIA allie tradition et modernité. Son esthétique gracieuse avec des lignes fines et une silhouette ouverte crée un équilibre entre éléments connus et nouveaux.

ES VAIA combina tradición y modernidad. Su encanto formal de líneas interesantes y una silueta abierta crea un equilibrio entre lo conocido y lo nuevo.



The Graceful



VAIA BRUSHED PLATINUM

graceful  
delicate  
balanced

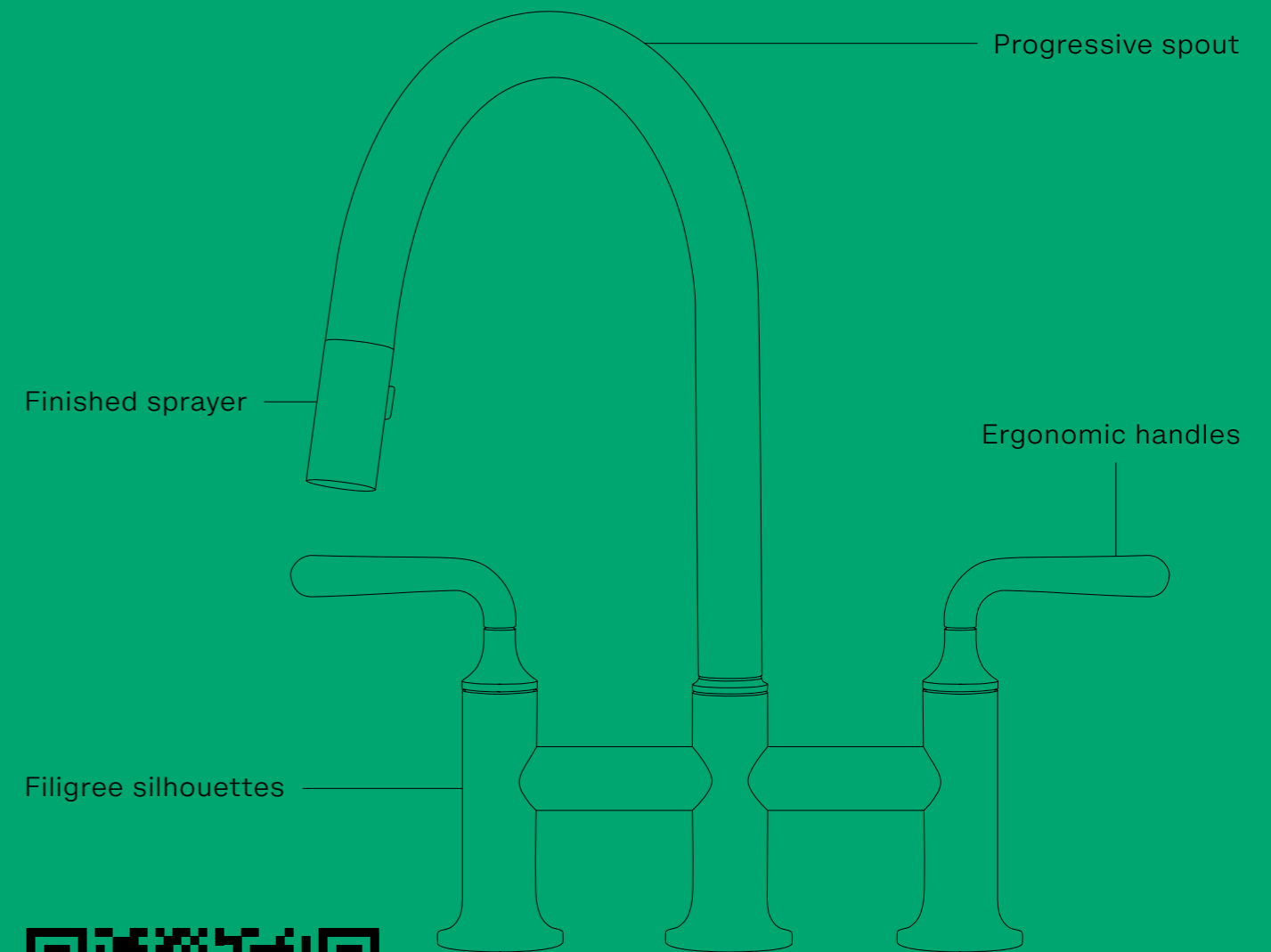

Find out more about VAIA at [dornbracht.com/vaia-kitchen](https://dornbracht.com/vaia-kitchen)



## Metropolitan Eclecticism

**EN** A modern kitchen with a metropolitan spirit, where matching style elements are combined in a variety of ways. The kitchen island and bar stools invite you to stay a while.

**FR** Une cuisine moderne servant également de salle de séjour avec un esprit métropolitain, dans laquelle des éléments de style coordonnés sont combinés de manière variée. L'îlot de cuisine et les tabourets de bar invitent à la détente.

**ES** Una cocina-comedor moderna de aire metropolitano en la que se combinan elementos de estilo a juego de forma variada. La isla de la cocina y los taburetes de bar invitan a pasar tiempo en este espacio.



<sup>EN</sup> VAIA shines in the warm finish Brushed Durabross (23kt gold), especially in combination with natural colors.

<sup>FR</sup> Dans la teinte chaude Laiton brossé (Or 23cts), VAIA brille particulièrement en association avec des couleurs naturelles.

<sup>ES</sup> En el cálido acabado Latón cepillado (Oro 23k) VAIA brilla especialmente en combinación con colores naturales.



According to  
Your Taste



**EN** The side sprayer and POT FILLER assist you with everyday tasks in the kitchen. Excellent design and high functionality that suits your needs and style.

**FR** Le POT FILLER et la douchette extractible latérale vous aident dans les tâches quotidiennes en cuisine. Un design exceptionnel s'allie ici à une grande fonctionnalité qui s'adapte à vos besoins et à votre style.

**ES** POT FILLER y el grifo de mano le respaldan a la hora de realizar movimientos cotidianos en la cocina. El magnífico diseño se combina aquí con una alta funcionalidad, que se adapta a sus demandas y a su estilo.





light linen  
oasis brown marble  
oak wood & asphalt  
screed  
kitchen wallpaper



# Materials





# VAIA Selected Products

**EN** Whether as a single-lever mixer or bridge faucet with levers or cross handles, discover VAIA in its many designs and options for your kitchen.

**FR** Qu'il s'agisse d'un mitigeur mono-commande, d'un mélangeur sur pont avec leviers ou poignées à croisillons : découvrez VAIA dans ses multiples versions et ses possibilités adaptées à votre cuisine.

**ES** Tanto en versión monomando, como en batería puente americana con manetas o crucetas: descubra VAIA en sus variadas ejecuciones y sus opciones adecuadas para su cocina.

Product Information  
 Information sur les produits  
 Información de producto

<sup>EN</sup> Excerpt from the product range.  
 More detailed information can be obtained from your dealer. Due to the printing technique used here, the colours shown may vary from the true colour of the actual finish.

<sup>FR</sup> Extrait de notre gamme de produits.  
 Pour des informations complètes, veuillez vous adresser à votre commerçant. Du fait des procédés d'impression, les couleurs présentées ici sont sans engagement de notre part.

<sup>ES</sup> Extracto del programa de productos.  
 Si desea más información consulte con su comercio habitual. Los acabados reproducidos en el presente catálogo no son vinculantes por razones de impresión.

Finishes for fittings  
 Finitions robinetteries  
 Acabados grifería



00  
 Chrome  
 Chrome  
 Cromo



93  
 Brushed Chrome  
 Chrome brossé  
 Cromo cepillado

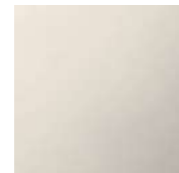

08  
 Platinum  
 Platine  
 Platino



06  
 Brushed Platinum  
 Platine brossé  
 Platino cepillado



47  
 Champagne (22kt Gold)  
 Champagne (Or 22cts)  
 Champagne (Oro 22k)



46  
 Brushed Champagne  
 (22kt Gold)  
 Champagne spazzolato  
 (Oro 22k)  
 Champagne cepillado  
 (Oro 22k)

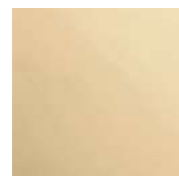

09  
 Durabress (23kt Gold)  
 Laiton (Or 23cts)  
 Latón (Oro 23k)



28  
 Brushed Durabress  
 (23kt Gold)  
 Laiton brossé (Or 23cts)  
 Latón cepillado (Oro 23k)



19  
 Dark Chrome  
 Dark Chrome  
 Dark Chrome



99  
 Brushed Dark Platinum  
 Dark Platinum brossé  
 Dark Platinum cepillado



33  
 Matte Black  
 Noir mat  
 Negro mate

Fittings  
 Robinetteries  
 Griferías



33 870 809  
 Single-lever mixer pull-down with spray function  
 Mitigeur monocommande Pull-down avec fonction douchette  
 Monomando Pull-down con función de chorro  
 [max. 1.5 gpm]



33 826 809 + 27 718 809  
 Single-lever mixer with rinsing spray set  
 Mitigeur monocommande avec douchette extractible  
 Monomando con rociador de cocina  
 [max. 1.5 gpm]



33 805 809  
 BAR TAP Single-lever mixer  
 BAR TAP Mitigeur monocommande  
 BAR TAP Monomando  
 [max. 1.5 gpm]



19 870 809  
 Three-hole bridge mixer pull-down with spray function  
 Mélangeur sur pont à trois trous Pull-down avec fonction douchette  
 Batería puente americana Pull-down con función de chorro  
 [max. 1.5 gpm]



33 800 809  
 Single-lever mixer  
 Mitigeur monocommande  
 Monomando  
 [max. 1.5 gpm]



19 875 809  
 Three-hole bridge mixer pull-down with spray function  
 Mélangeur sur pont à trois trous Pull-down avec fonction douchette  
 Batería puente americana Pull-down con función de chorro  
 [max. 1.5 gpm]



33 810 809 + 27 718 809  
 Single-lever mixer with rinsing spray set  
 Mitigeur monocommande avec douchette extractible  
 Monomando con rociador de cocina  
 [max. 1.5 gpm]



19 815 809 + 27 718 809  
 Two-hole bridge mixer with rinsing spray set  
 Mélangeur sur pont à 2 trous avec douchette extractible  
 Batería de puente con rociador de cocina  
 [max. 1.5 gpm]



33 816 809  
 Single-lever mixer  
 Mitigeur monocommande  
 Monomando  
 [max. 1.5 gpm]



19 825 809 + 27 718 809  
 Two-hole bridge mixer with rinsing spray set  
 Mélangeur sur pont à 2 trous avec douchette extractible  
 Batería de puente con rociador de cocina  
 [max. 1.5 gpm]

Fittings  
Robinetteries  
Griferías



30 805 809 <sup>a</sup>  
POT FILLER Cold water valve  
POT FILLER robinet d'eau froide  
POT FILLER Válvula de agua fría  
[max. 1.5 gpm]

Accessories  
Accessoires  
Complementos



82 434 809  
Soap dispenser with flange  
Distributeur avec rosace  
Dispensador con roseta



83 251 809 <sup>b</sup>  
Hook  
Patère  
Gancho



10 713 809  
AIR SWITCH operating button,  
trim parts only  
AIR SWITCH bouton de  
commande de broyeur  
AIR SWITCH botón de manejo



83 060 809 <sup>b</sup>  
Towel bar  
Porte-serviette de bain  
Barra colgador

Find out more about VAIA at  
[Dornbracht/VAIA.com](https://www.dornbracht.com/VAIA)





# MEM

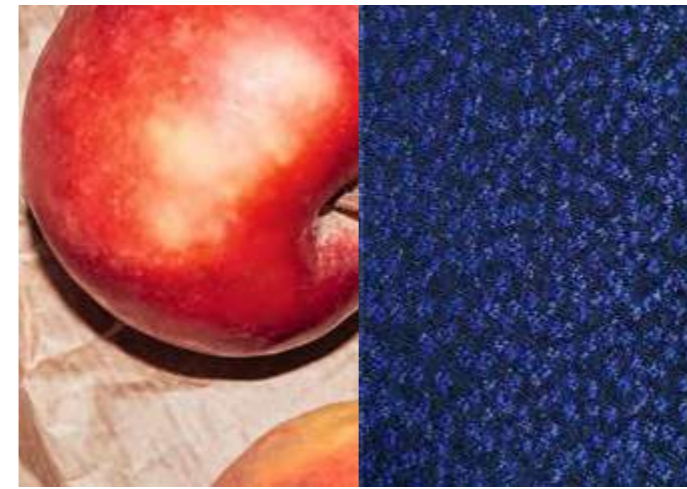



## The Pure



**EN** The clarity and elemental simplicity of MEM is reminiscent of a natural water source. Its sleek and straightforward lines exude a strong yet modest presence.

**FR** Par sa clarté et son originalité, MEM rappelle une source d'eau naturelle. Sa forme élémentaire dégage une forte présence, tout en retenue.

**ES** Con su claridad y genuinidad, MEM recuerda a un manantial natural. Su forma elemental irradia una gran presencia, siendo discreta al mismo tiempo.



MEM CHAMPAGNE (22KT GOLD)

pure  
elemental  
confident

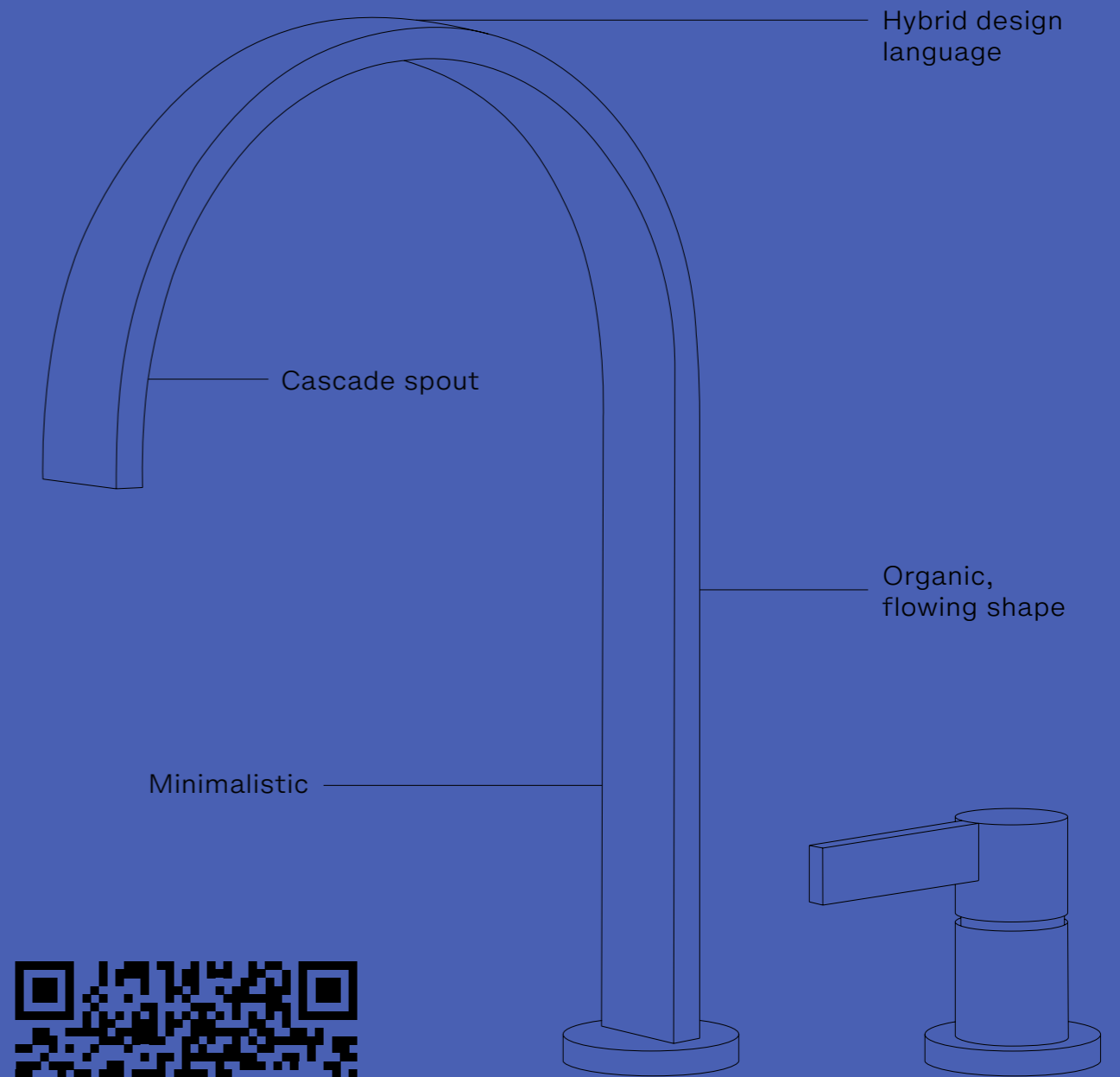

Find out more about MEM at [dornbracht.com/mem-kitchen](https://dornbracht.com/mem-kitchen)



## Urban Greenery

**EN** For those who love nature as much as the city. Plants, earthy tones and minimalist lines form a harmonious ensemble in the light-flooded kitchen.

**FR** Pour toutes les personnes qui aiment la nature autant que leur ville. Des plantes, des tons terreux et des formes minimalistes créent un ensemble harmonieux dans la cuisine inondée de lumière.

**ES** Para todos aquellos que aman la naturaleza tanto como a la ciudad. Las plantas, los tonos terrosos y las formas minimalistas forman un conjunto armonioso en la cocina repleta de luz.





<sup>EN</sup> Practical convenience in your designer kitchen: MEM two-hole in combination with a side sprayer.

<sup>FR</sup> Pour un confort pratique dans la cuisine design : MEM à deux trous en combinaison avec la douchette extractible latérale.

<sup>ES</sup> Para un práctico confort en la cocina de diseño: MEM de dos orificios en combinación con juego de ducha lateral.



EN MEM's seamless lines embody a steady flow and reflect its special design language. The integrated aerator ensures a soft, air-enriched stream.

FR Les lignes continues de MEM représentent un écoulement constant et reflètent son langage formel particulier. Le mousseur intégré garantit un jet doux enrichi d'air.

ES Las líneas ininterrumpidas en MEM plasman un flujo continuo y reflejan su lenguaje formal especial. Un mezclador integrado ofrece un chorro suave enriquecido con aire.

Elemental  
Virtuosity



organic fabrics  
black terrazzo  
screed  
steel & walnut wood



# Materials





# MEM

## Selected Products

**EN** Discover the MEM product portfolio: the BAR TAP for a refreshing glass of water between meals, one of several accessories for your kitchen.

**FR** Découvrez le portefeuille de produits de MEM : le BAR TAP pour un verre d'eau rafraîchissant entre les repas ainsi que d'autres accessoires pour votre cuisine.

**ES** Descubra la gama de productos de MEM: BAR TAP, para tomar un refrescante vaso de agua de vez en cuando, así como más complementos para su cocina.

Product Information  
 Information sur les produits  
 Información de producto

<sup>EN</sup> Excerpt from the product range.  
 More detailed information can be obtained from your dealer. Due to the printing technique used here, the colours shown may vary from the true colour of the actual finish.

<sup>FR</sup> Extrait de notre gamme de produits.  
 Pour des informations complètes, veuillez vous adresser à votre commerçant. Du fait des procédés d'impression, les couleurs présentées ici sont sans engagement de notre part.

<sup>ES</sup> Extracto del programa de productos.  
 Si desea más información consulte con su comercio habitual. Los acabados reproducidos en el presente catálogo no son vinculantes por razones de impresión.

Finishes for fittings  
 Finitions robinetteries  
 Acabados grifería



00  
 Chrome  
 Chrome  
 Cromo



93  
 Brushed Chrome  
 Chrome brossé  
 Cromo cepillado

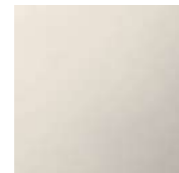

08  
 Platinum  
 Platine  
 Platino



06  
 Brushed Platinum  
 Platine brossé  
 Platino cepillado



47  
 Champagne (22kt Gold)  
 Champagne (Or 22cts)  
 Champagne (Oro 22k)



46  
 Brushed Champagne  
 (22kt Gold)  
 Champagne spazzolato  
 (Oro 22k)  
 Champagne cepillado  
 (Oro 22k)

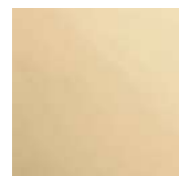

09  
 Durabress (23kt Gold)  
 Laiton (Or 23cts)  
 Latón (Oro 23k)



28  
 Brushed Durabress  
 (23kt Gold)  
 Laiton brossé (Or 23cts)  
 Latón cepillado (Oro 23k)



19  
 Dark Chrome  
 Dark Chrome  
 Dark Chrome

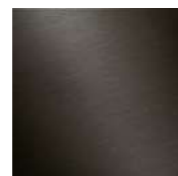

99  
 Brushed Dark Platinum  
 Dark Platinum brossé  
 Dark Platinum cepillado



33  
 Matte Black  
 Noir mat  
 Negro mate

Fittings  
 Robinetteries  
 Griferías



33 805 682  
 BAR TAP Single-lever mixer  
 BAR TAP Mitigeur monocommande  
 BAR TAP Monomando  
 [max. 1.5 gpm]



32 815 682 + 27 799 970 <sup>a</sup>  
 Two-hole mixer with individual  
 rosettes with profi spray set  
 Mitigeur à deux trous avec rosaces  
 individuelles avec douchette  
 pendulaire  
 Batería monomando de dos orificios  
 con rosetas individuales  
 con rociador de cocina profesional  
 [max. 1.5 gpm]



33 800 682  
 Single-lever mixer  
 Mitigeur monocommande  
 Monomando  
 [max. 1.5 gpm]



33 815 682  
 Single-lever mixer  
 Mitigeur monocommande  
 Monomando  
 [max. 1.5 gpm]



32 815 682  
 Two-hole mixer  
 with individual flanges  
 Mitigeur à deux trous  
 avec rosaces individuelles  
 Batería monomando de dos  
 orificios con rosetas individuales  
 [max. 1.5 gpm]



32 815 682 + 27 731 970  
 Two-hole mixer with individual  
 rosettes with rinsing spray set  
 Mitigeur à deux trous avec rosaces  
 individuelles avec douchette  
 extractible  
 Batería monomando de dos  
 orificios con rosetas individuales  
 con rociador de cocina  
 [max. 1.5 gpm]

<sup>a</sup> Item not available in finishes 47, 46, 09, 28 and 33. / Article non disponible dans les finitions 47, 46, 09, 28 et 33. / Artículo no disponible en los acabados 47, 46, 09, 28 y 33.

Accessories  
Accessoires  
Complementos



27 713 970  
Side spray set  
Douchette extractible  
Rociador de cocina



83 251 220  
Hook  
Patère  
Gancho



82 424 970  
Soap dispenser without flange  
Distributeur sans rosace  
Dispensador sin roseta



83 060 979<sup>b</sup>  
Towel bar  
Porte-serviette de bain  
Barra colgador



10 713 970  
AIR SWITCH operating button,  
trim parts only  
AIR SWITCH bouton de  
commande de broyeur  
AIR SWITCH botón de manejo



83 080 979<sup>b</sup>  
Towel bar  
Porte-serviette de bain  
Barra colgador



10 712 970  
Strainer remote control  
with turning knob  
Commande de vidage  
individuelle manuelle  
Commande manuelle  
Accionamiento excéntrico manual  
con maneta de control giratoria



12 715 970  
Cover for tap hole  
Cache pour percement  
de robinetterie  
Tapón de orificio

Find out more about MEM at  
Dornbracht/MEM.com





META



SQUARE

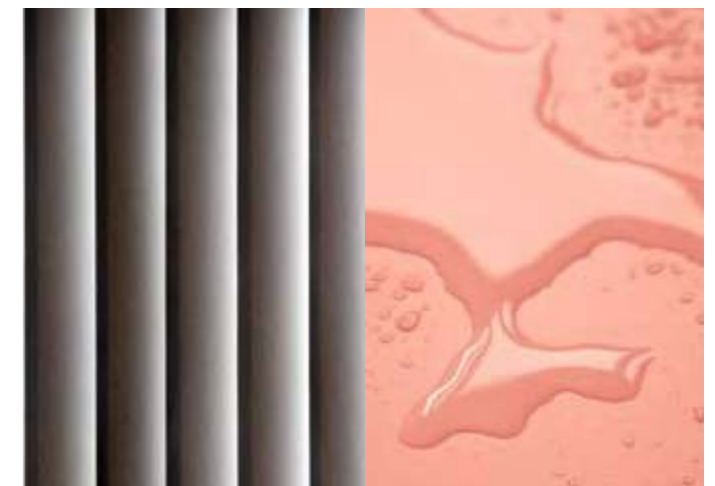





**EN** A slender and geometric design is what makes META SQUARE so versatile. The double curved spout and the cylindrical design elements are characteristic for this series.

**FR** Sa forme élancée et géométrique rend META SQUARE particulièrement polyvalente. Elle se caractérise par son bec doublement courbé et ses éléments de forme cylindrique.

**ES** Su forma esbelta y geométrica aporta a META SQUARE una gran versatilidad. La caracterizan el caño de salida de curvatura doble y sus elementos formales cilíndricos.



The Versatile



META SQUARE BRUSHED CHAMPAGNE (22KT GOLD)

versatile  
individual  
refined

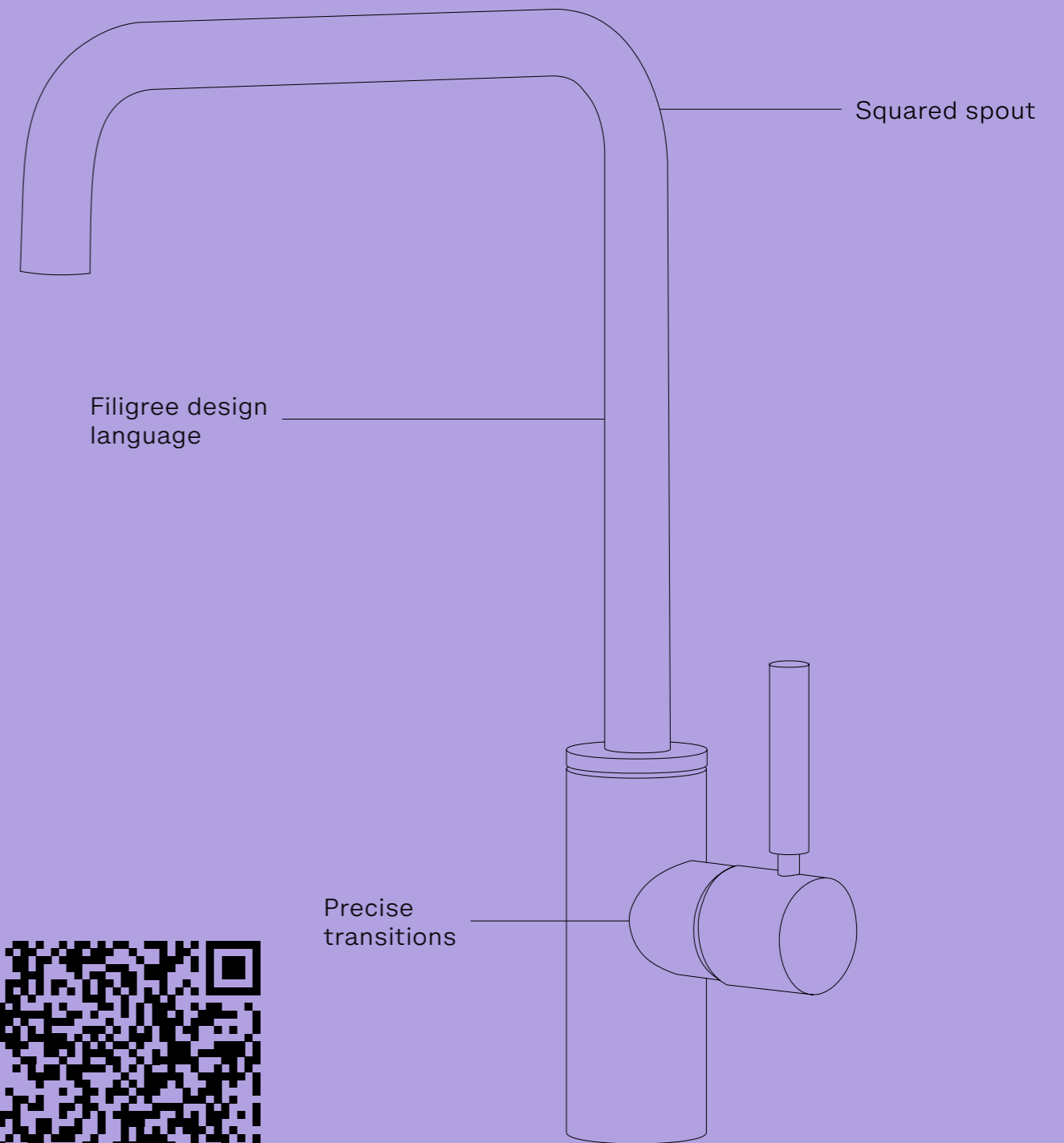

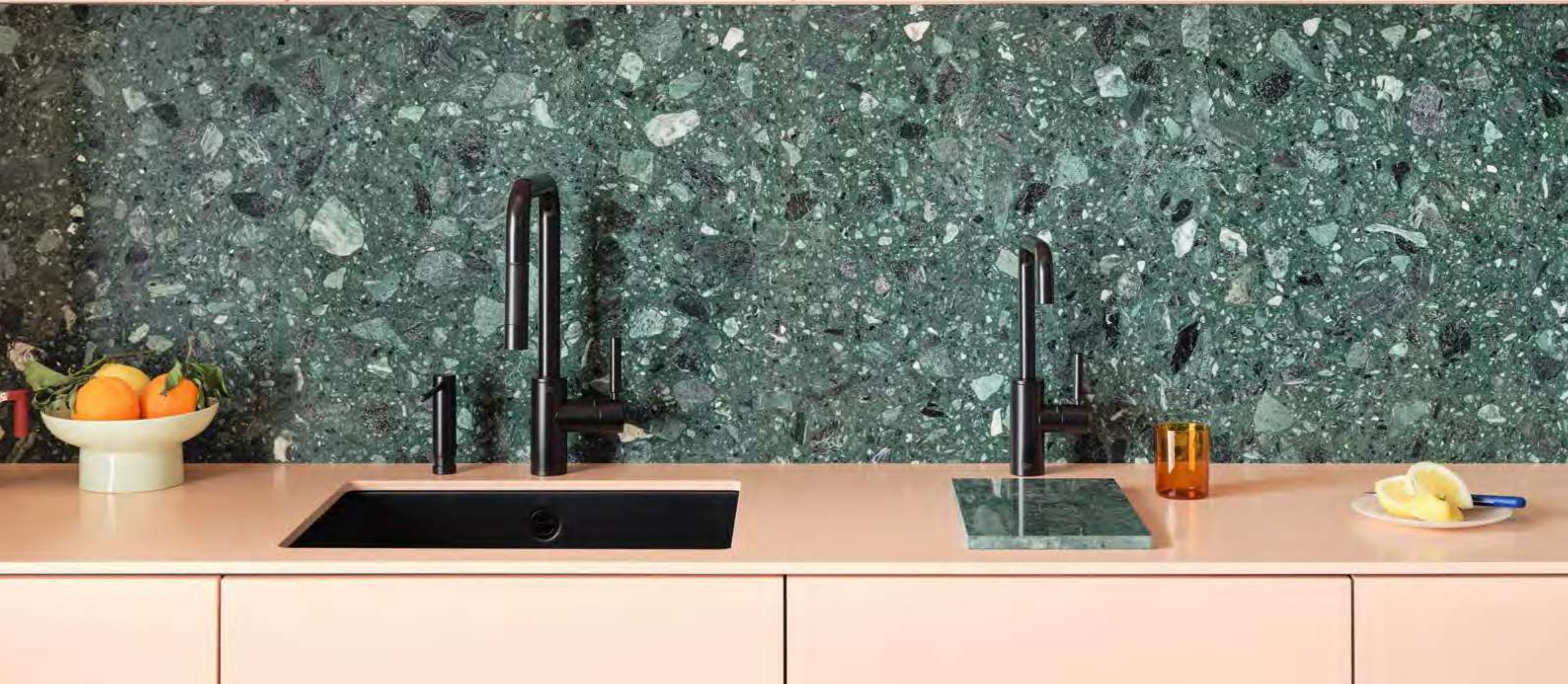

## Cosmopolitan Fusion

<sup>EN</sup> META SQUARE in Matte Black meets an experimental liaison of pink fronts and dark green terrazzo back panels.

<sup>FR</sup> META SQUARE en Noir mat établit une liaison expérimentale entre des façades roses et des parois arrière en terrazzo vert foncé.

<sup>ES</sup> META SQUARE en Negro mate forma una alianza experimental de frentes en rosa y paneles traseros en Terrazzo verde oscuro.



<sup>EN</sup> In the finish Brushed Champagne (22kt Gold), META SQUARE brings cosmopolitan flair to the kitchen.

<sup>FR</sup> Dans la finition Champagne brossé (Or 22cts), META SQUARE apporte une touche cosmopolite à la cuisine.

<sup>ES</sup> En el acabado Champagne cepillado (Oro 22k), META SQUARE aporta un aire cosmopolita a la cocina.

## A Kitchen – As Individual As You



**EN** META SQUARE also impresses with its versatility. BAR TAP and the convenient rinsing spray set with shower spray are the perfect complement to the single-lever mixer.

**FR** Sur le plan fonctionnel aussi, META SQUARE convainc par sa polyvalence. Le BAR TAP et la confortable douchette extractible avec jet douchette complètent parfaitement le mitigeur monocommande.

**ES** META SQUARE también convence en cuanto a funcionalidad por su versatilidad. BAR TAP y el confortable juego de grifo de cocina con chorro de ducha son el complemento perfecto para el mezclador monomando.

stainless steel  
green terrazzo  
lush rose  
matte black

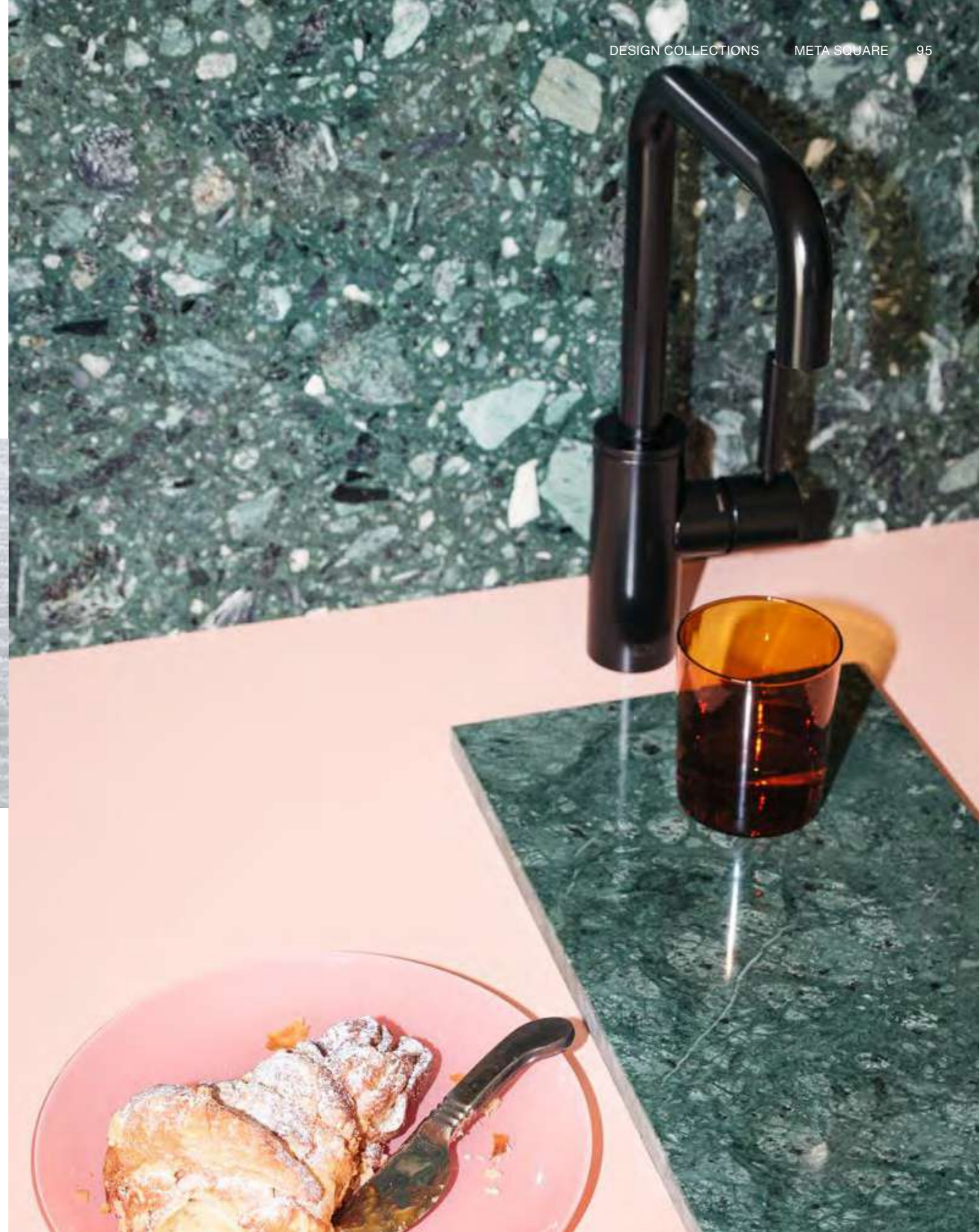
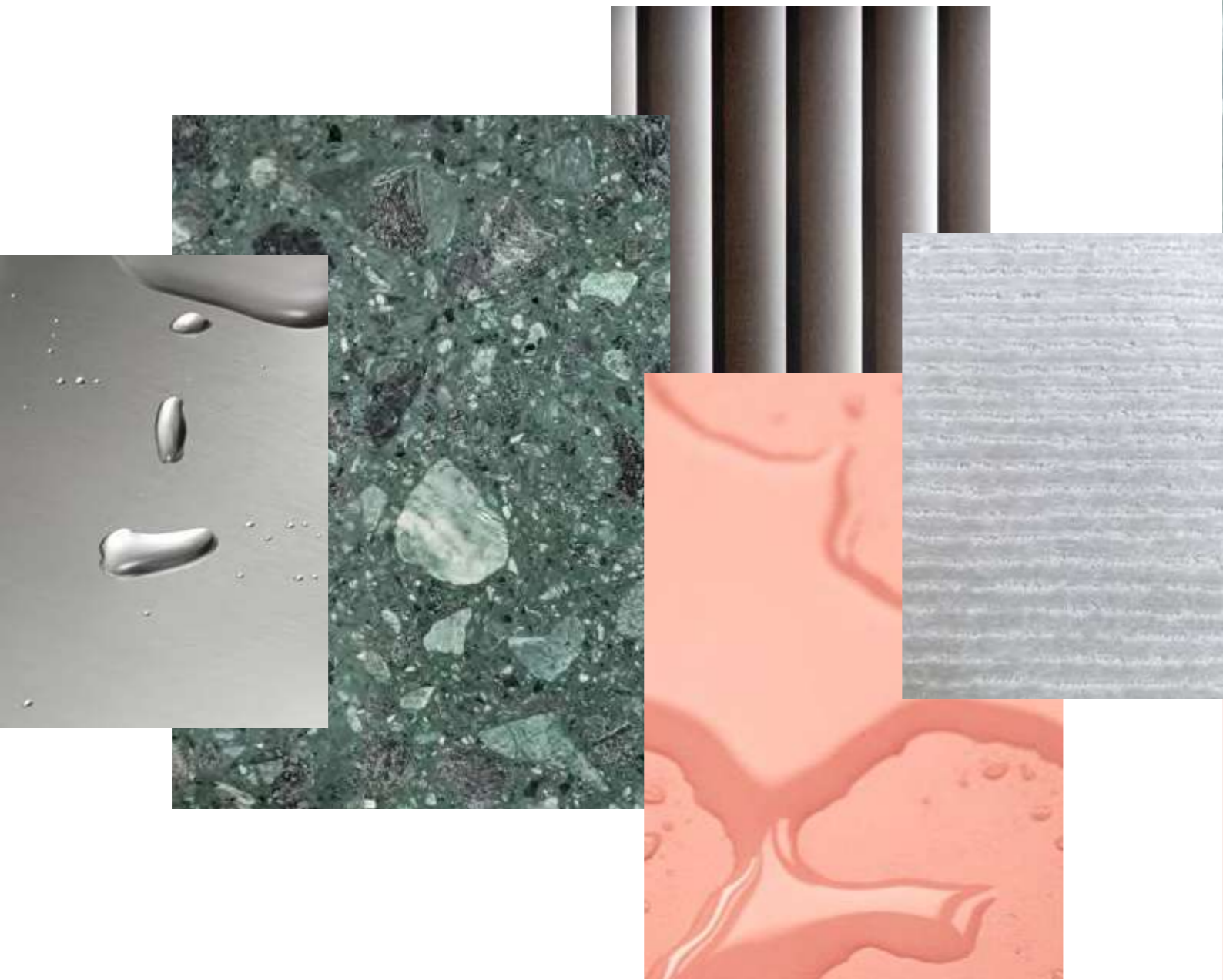

# Materials

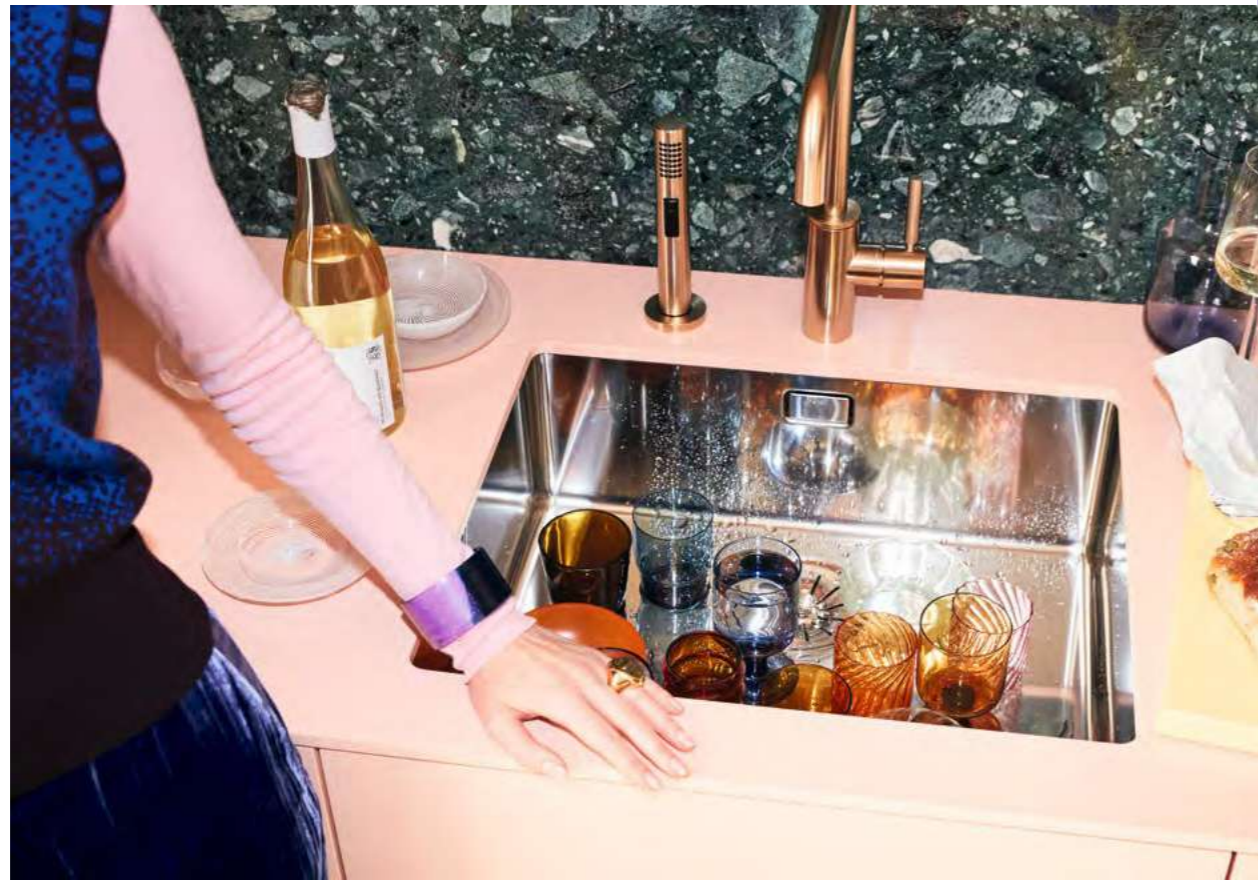

EN The META SQUARE series offers you freedom of design: in addition to the classic single-lever mixer, there is, among other things, a pull-out variant with a PULL-DOWN function and shower spray.

FR La série META SQUARE vous offre une grande liberté de conception : outre le mitigeur monocommande classique, il existe entre autres une variante extensible avec fonction PULL-DOWN et jet douchette.

ES La serie META SQUARE le ofrece libertad de diseño: además de la versión monomando clásico, entre otras, se ofrece una variante extraíble como PULL-DOWN y chorro de ducha.

# META SQUARE Selected Products

Product Information  
 Information sur les produits  
 Información de producto

<sup>EN</sup> Excerpt from the product range.  
 More detailed information can be obtained from your dealer. Due to the printing technique used here, the colours shown may vary from the true colour of the actual finish.

<sup>FR</sup> Extrait de notre gamme de produits.  
 Pour des informations complètes, veuillez vous adresser à votre commerçant. Du fait des procédés d'impression, les couleurs présentées ici sont sans engagement de notre part.

<sup>ES</sup> Extracto del programa de productos.  
 Si desea más información consulte con su comercio habitual. Los acabados reproducidos en el presente catálogo no son vinculantes por razones de impresión.

Finishes for fittings  
 Finitions robinetteries  
 Acabados grifería



00  
 Chrome  
 Chrome  
 Cromo



93  
 Brushed Chrome  
 Chrome brossé  
 Cromo cepillado

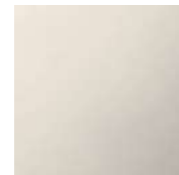

08  
 Platinum  
 Platine  
 Platino



06  
 Brushed Platinum  
 Platine brossé  
 Platino cepillado



47  
 Champagne (22kt Gold)  
 Champagne (Or 22cts)  
 Champagne (Oro 22k)



46  
 Brushed Champagne  
 (22kt Gold)  
 Champagne spazzolato  
 (Oro 22k)  
 Champagne cepillado  
 (Oro 22k)

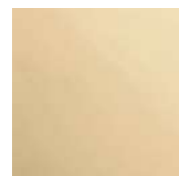

09  
 Durabress (23kt Gold)  
 Laiton (Or 23cts)  
 Latón (Oro 23k)



28  
 Brushed Durabress  
 (23kt Gold)  
 Laiton brossé (Or 23cts)  
 Latón cepillado (Oro 23k)



19  
 Dark Chrome  
 Dark Chrome  
 Dark Chrome



99  
 Brushed Dark Platinum  
 Dark Platinum brossé  
 Dark Platinum cepillado



33  
 Matte Black  
 Noir mat  
 Negro mate

Fittings  
 Robinetteries  
 Griferías



33 870 861  
 Single-lever mixer pull-down with spray function  
 Mitigeur monocommande Pull-down avec fonction douchette  
 Monomando Pull-down con función de chorro  
 [max. 1.5 gpm]



33 826 861 + 27 731 970  
 Single-lever mixer with rinsing spray set  
 Mitigeur monocommande avec douchette extractible  
 Monomando con rociador de cocina  
 [max. 1.5 gpm]



17 861 625 <sup>a</sup>  
 HOT & COLD WATER DISPENSER  
 HOT & COLD WATER DISPENSER  
 HOT & COLD WATER DISPENSER  
 [max. 0.5 gpm]



33 826 861 + 27 799 970 <sup>b</sup>  
 Single-lever mixer with profi spray set  
 Mitigeur monocommande avec douchette pendulaire  
 Monomando con rociador de cocina profesional  
 [max. 1.5 gpm]



33 805 861  
 BAR TAP Single-lever mixer  
 BAR TAP Mitigeur monocommande  
 BAR TAP Monomando  
 [max. 1.5 gpm]



32 815 861  
 Two-hole mixer with individual flanges  
 Mitigeur à deux trous avec rosaces individuelles  
 Batería monomando de dos orificios con rosetas individuales  
 [max. 1.5 gpm]



33 800 861  
 Single-lever mixer  
 Mitigeur monocommande  
 Monomando  
 [max. 1.5 gpm]



32 815 861 + 27 731 970  
 Two-hole mixer with individual rosettes with rinsing spray set  
 Mitigeur à deux trous avec rosaces individuelles avec douchette extractible  
 Batería monomando de dos orificios con rosetas individuales con rociador de cocina  
 [max. 1.5 gpm]



33 815 861  
 Single-lever mixer  
 Mitigeur monocommande  
 Monomando  
 [max. 1.5 gpm]



32 815 861 + 27 799 970 <sup>b</sup>  
 Two-hole mixer with individual rosettes with profi spray set  
 Mitigeur à deux trous avec rosaces individuelles avec douchette pendulaire  
 Batería monomando de dos orificios con rosetas individuales con rociador de cocina profesional  
 [max. 1.5 gpm]

<sup>a</sup> You need the corresponding system components for this product. / Pour ce produit, vous avez besoin des composants système correspondants. / Para este producto necesita los componentes de sistema adecuados.

<sup>b</sup> Item not available in finishes 47, 46, 09, 28 and 33. / Article non disponible dans les finitions 47, 46, 09, 28 et 33. / Artículo no disponible en los acabados 47, 46, 09, 28 y 33.



Fittings  
Robinetteries  
Griferías



30 805 875 <sup>c</sup>  
POT FILLER Cold water valve  
POT FILLER robinet d'eau froide  
POT FILLER Válvula de agua fría  
[max. 1.5 gpm]

Accessories  
Accessoires  
Complementos



27 713 970  
Side spray set  
Douchette extractible  
Rociador de cocina



12 715 970  
Cover for tap hole  
Cache pour percement  
de robinetterie  
Cache pour percement  
de robinetterie



82 424 970  
Soap dispenser without flange  
Distributeur sans rosace  
Distributeur sans rosace



83 251 220  
Hook  
Patère  
Gancho



10 713 970  
AIR SWITCH operating button,  
trim parts only  
AIR SWITCH bouton de  
commande de broyeur  
AIR SWITCH botón de manejo

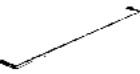

83 060 979 <sup>d</sup>  
Towel bar  
Porte-serviette de bain  
Barra colgador



10 712 970  
Strainer remote control with  
turning knob  
Commande de vidage individuelle  
manuelle Commande manuelle  
Accionamiento excéntrico manual con  
maneta de control giratoria

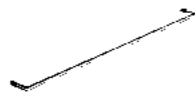

83 080 979 <sup>d</sup>  
Towel bar  
Porte-serviette de bain  
Barra colgador

Find out more about META SQUARE at  
Dornbracht/Metasquare.com



<sup>c</sup> A rough parts kit is required for this article. Item not available in finish 33. / Un corps à encastrer est nécessaire pour l'installation de cet article. Article non disponible dans la finition 33. / Se requiere un kit de partes empotradas para este artículo. Artículo no disponible en el acabado 33.  
<sup>d</sup> Item not available in finishes 08, 09 and 99. / Article non disponible dans les finitions 08, 09 et 99. / Artículo no disponible en los acabados 08, 09 y 99.



# TARA





**EN** TARA is a modern archetype. Ideal symmetry, striking precision and timeless modernity characterize the iconic design of TARA, which never goes out of style.

**FR** TARA est un archétype moderne. Sa forme emblématique : d'une symétrie idéale, d'une précision marquée et d'une modernité intemporelle. Un objet design qui ne perd jamais de son actualité.

**ES** TARA es un arquetipo moderno. Su forma icónica: de simetría ideal, marcada precisión y modernidad atemporal. Un objeto de diseño que nunca pierde en actualidad.



The Archetype



TARA DURABRASS (23KT GOLD)

archetypal  
modern  
perfected

180° arched spout

Iconic design

Timeless





## Timeless Comfort

<sup>EN</sup> Inspired by the vibrant open kitchen concept, the design classic TARA creates an inviting atmosphere, blending naturally into fusions of classic and modern elements.

<sup>FR</sup> Inspiré du style américain de la cuisine ouverte pleine de vie, il en résulte une atmosphère accueillante : le classique du design TARA s'intègre tout naturellement dans la combinaison d'éléments classiques et modernes.

<sup>ES</sup> Inspirado en el estilo americano de cocina abierta, el resultado es un ambiente acogedor: el clásico del diseño TARA encaja naturalmente en la combinación de elementos clásicos y modernos.



<sup>EN</sup> The classic Dornbracht fitting TARA in the finish Brushed Champagne (22kt Gold) unites proven design with timeless appeal.

<sup>FR</sup> En tant que classique, TARA dans la finition Champagne brossé (Or 22cts) allie un design éprouvé à une exigence intemporelle.

<sup>ES</sup> Como clásico, TARA combina un acreditado diseño con pretensiones atemporales en su acabado Champagne cepillado (Oro 22k).

# Perfect Kitchen Feeling



**EN** Stylish convenience: the POT FILLER allows you to fill pots directly next to the stove, while Air Switch offers an elegant solution for waste disposal.

**FR** La maîtrise des styles associée à un confort optimal : le POT FILLER permet un remplissage direct sur le plan de cuisson, l'Air Switch offre une solution élégante pour le broyage des déchets.

**ES** Estilo seguro con máximo confort: POT FILLER permite llenar ollas y recipientes directamente en la placa de cocina, y Air Switch ofrece una solución elegante para la trituradora de basura.





lime plaster  
calacatta oro marble  
stained oak & linen  
travertine tiles



# Materials





**EN** TARA is style-defining in a wide variety of interiors, offering you a curated selection of finishes and an exceptional range of available products. Discover the inspiring variety of this classic series.

**FR** TARA marque le style dans une grande variété d'intérieurs et vous offre une sélection de finitions et une richesse d'assortiment exceptionnelle. Découvrez la diversité inspirante de cette série classique.

**ES** TARA marca estilo en los interiores más versátiles y le ofrece una gran selección de acabados y una gama especialmente amplia. Descubra la gran variedad inspiradora de este clásico.



# TARA

## Selected Products

Product Information  
 Information sur les produits  
 Información de producto

<sup>EN</sup> Excerpt from the product range.  
 More detailed information can be obtained from your dealer. Due to the printing technique used here, the colours shown may vary from the true colour of the actual finish.

<sup>FR</sup> Extrait de notre gamme de produits.  
 Pour des informations complètes, veuillez vous adresser à votre commerçant. Du fait des procédés d'impression, les couleurs présentées ici sont sans engagement de notre part.

<sup>ES</sup> Extracto del programa de productos.  
 Si desea más información consulte con su comercio habitual. Los acabados reproducidos en el presente catálogo no son vinculantes por razones de impresión.

Finishes for fittings  
 Finitions robinetteries  
 Acabados grifería



00  
 Chrome  
 Chrome  
 Cromo



93  
 Brushed Chrome  
 Chrome brossé  
 Cromo cepillado

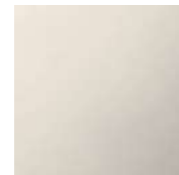

08  
 Platinum  
 Platine  
 Platino



06  
 Brushed Platinum  
 Platine brossé  
 Platino cepillado



47  
 Champagne (22kt Gold)  
 Champagne (Or 22cts)  
 Champagne (Oro 22k)



46  
 Brushed Champagne  
 (22kt Gold)  
 Champagne spazzolato  
 (Oro 22k)  
 Champagne cepillado  
 (Oro 22k)

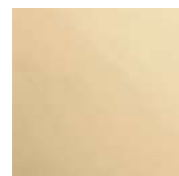

09  
 Durabress (23kt Gold)  
 Laiton (Or 23cts)  
 Latón (Oro 23k)



28  
 Brushed Durabress  
 (23kt Gold)  
 Laiton brossé (Or 23cts)  
 Latón cepillado (Oro 23k)



19  
 Dark Chrome  
 Dark Chrome  
 Dark Chrome



99  
 Brushed Dark Platinum  
 Dark Platinum brossé  
 Dark Platinum cepillado



33  
 Matte Black  
 Noir mat  
 Negro mate

Fittings  
 Robinetteries  
 Griferías



33 870 888  
 Single-lever mixer pull-down with spray function  
 Mitigeur monocommande Pull-down avec fonction douchette  
 Monomando Pull-down con función de chorro  
 [max. 1.5 gpm]



33 815 888  
 Single-lever mixer  
 Mitigeur monocommande  
 Monomando  
 [max. 1.5 gpm]



33 880 888<sup>a</sup>  
 Profi single-lever mixer  
 Mitigeur monocommande Profi  
 Monomando Profi  
 [max. 1.5 gpm]



33 826 888 + 27 721 970  
 Single-lever mixer with rinsing spray set  
 Mitigeur monocommande avec douchette extractible  
 Monomando con rociador de cocina  
 [max. 1.5 gpm]



17 861 888<sup>b</sup>  
 HOT & COLD WATER DISPENSER  
 HOT & COLD WATER DISPENSER  
 HOT & COLD WATER DISPENSER  
 [max. 0.5 gpm]



33 826 888 + 27 789 970<sup>a</sup>  
 Single-lever mixer with profi spray set  
 Mitigeur monocommande avec douchette pendulaire  
 Monomando con rociador de cocina profesional  
 [max. 1.5 gpm]



33 805 888  
 BAR TAP Single-lever mixer  
 BAR TAP Mitigeur monocommande  
 BAR TAP Monomando  
 [max. 1.5 gpm]



32 815 888  
 Two-hole mixer with individual flanges  
 Mitigeur à deux trous avec rosaces individuelles  
 Batería monomando de dos orificios con rosetas individuales  
 [max. 1.5 gpm]



33 800 888  
 Single-lever mixer  
 Mitigeur monocommande  
 Monomando  
 [max. 1.5 gpm]



32 815 888 + 27 721 970  
 Two-hole mixer with individual rosettes with rinsing spray set  
 Mitigeur à deux trous avec rosaces individuelles avec douchette extractible  
 Batería monomando de dos orificios con rosetas individuales con rociador de cocina  
 [max. 1.5 gpm]

<sup>a</sup> Item not available in finishes 47, 46, 09, 28 and 33. / Article non disponible dans les finitions 47, 46, 09, 28 et 33. / Artículo no disponible en los acabados 47, 46, 09, 28 y 33.

<sup>b</sup> You need the corresponding system components for this product. / Pour ce produit, vous avez besoin des composants système correspondants. / Para este producto necesita los componentes de sistema adecuados.

Fittings  
Robinetteries  
Griferías



32 815 888 + 27 789 970 °  
Two-hole mixer with individual rosettes with profi spray set  
Mítigeur à deux trous avec rosaces individuelles avec douchette pendulaire  
Batería monomando de dos orificios con rosetas individuales con rociador de cocina profesional  
[max. 1.5 gpm]



20 815 892 + 27 721 970  
Three-hole mixer with rinsing spray set  
Mélangeur à trois trous avec douchette extractible  
Mélangeur à trois trous avec douchette extractible  
[max. 1.5 gpm]



10 713 970  
AIR SWITCH operating button, trim parts only  
AIR SWITCH bouton de commande de broyeur  
AIR SWITCH botón de manejo



83 251 892  
Hook  
Patère  
Gancho



22 815 892  
Single-hole mixer  
Mélangeur monotrou  
Grifo mezclador con un orificio  
[max. 1.5 gpm]



20 815 892 + 27 789 970 °  
Three-hole mixer with profi spray set  
Mélangeur à trois trous avec douchette pendulaire  
Batería americana con rociador de cocina profesional  
[max. 1.5 gpm]



10 710 970  
Strainer remote control with turning knob  
Commande de vidage individuelle manuelle Commande manuelle  
Accionamiento excéntrico manual con maneta de control giratoria



83 045 892 9  
Towel bar  
Porte-serviette de bain  
Barra colgador



20 815 892  
Three-hole mixer  
Mélangeur à trois trous  
Batería americana  
[max. 1.5 gpm]



30 805 875 °  
POT FILLER Cold water valve  
POT FILLER robinet d'eau froide  
POT FILLER rubinetto acqua fredda con bocca girevole  
[max. 1.5 gpm]



12 715 970  
Cover for tap hole  
Cache pour percement de robinetterie  
Tapón de orificio



83 060 892 9  
Towel bar  
Porte-serviette de bain  
Barra colgador



83 251 979 †  
Hook  
Patère  
Gancho



83 080 892 9  
Towel bar  
Porte-serviette de bain  
Barra colgador

Accessories  
Accessoires  
Complementos



27 718 970  
Side spray set  
Douchette extractible  
Rociador de cocina



82 444 970  
Soap dispenser with flange  
Distributeur avec rosace  
Dispensador con roseta



83 256 979 †  
Hook in two parts  
Patère en deux parties  
Gancho de dos piezas

° Item not available in finishes 47, 46, 09, 28 and 33. / Article non disponible dans les finitions 47, 46, 09, 28 et 33. / Artículo no disponible en los acabados 47, 46, 09, 28 y 33.

† Item not available in finish 33. / Article non disponible dans la finition 33. / Artículo no disponible en el acabado 33.

\* A rough parts kit is required for this article. Item not available in finish 33. / Un corps à encastrer est nécessaire pour l'installation de cet article. Article non disponible dans la finition 33. / Se requiere un kit de partes empotradas para este artículo. Artículo no disponible en el acabado 33.

9 Item not available in finishes 08 and 09. / Article non disponible dans les finitions 08 et 09. / Artículo no disponible en los acabados 08 y 09. / Artículo no disponible en la finition 09. / Artículo no disponible en el acabado 09.

Find out more about TARA at  
Dornbracht/Tara.com





TARA



ULTRA





**EN** TARA ULTRA: versatile and function-oriented. With its high spout and ergonomic handle, it covers a wide range of applications: from single-lever mixers with or without side sprayers, to PULL-DOWN fittings and professional fittings.

**FR** TARA ULTRA se veut polyvalente et axée sur la fonctionnalité. Avec son bec haut et sa poignée positionnée de manière ergonomique, elle couvre divers domaines d'application : du mitigeur monocommande avec ou sans douche extractible latérale à la robinetterie Profi en passant par la robinetterie PULL-DOWN.

**ES** Versátil y funcional: así es TARA ULTRA. Con su elevado caño de salida y su maneta colocada ergonómicamente, abarca los diferentes campos de aplicación: desde el mezclador monomando con o sin juego de ducha lateral, la grifería PULL-DOWN y hasta la grifería Profi.



The Functional



TARA ULTRA BRUSHED PLATINUM

functional  
modern  
specific

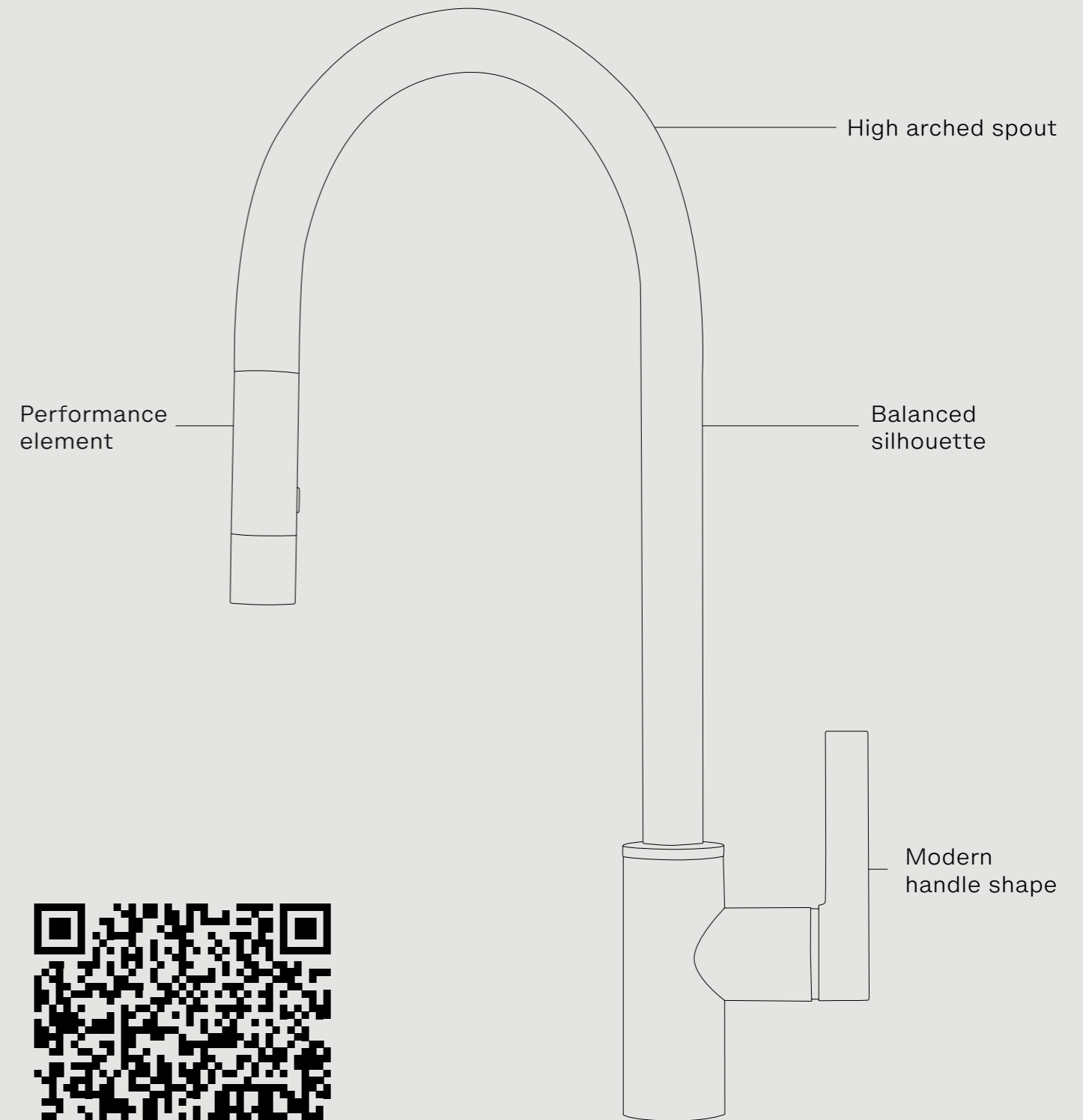

Find out more about TARA ULTRA at [dornbracht.com/tara-ultra](https://dornbracht.com/tara-ultra)





## Sophisticated Steel

**EN** Harmonious interaction for modern, function-oriented kitchens: TARA ULTRA meets soft nuances and matte finishes and materials.

**FR** Une interaction harmonieuse pour des cuisines modernes et fonctionnelles : TARA ULTRA associe des nuances douces et des finitions et matériaux mats.

**ES** Un conjunto armonioso para cocinas modernas y funcionales: TARA ULTRA se fusiona con suaves tonalidades y acabados y materiales mate.



<sup>EN</sup> The high, extendable spout provides room for flexible and easy handling.

<sup>FR</sup> Le bec haut et extensible offre une grande flexibilité de manipulation.

<sup>ES</sup> El alto caño extraíble ofrece libertad para un manejo flexible.

EN A professional tool for your kitchen: with the practical POT FILLER, the PULL-DOWN fitting, or the professional version of TARA ULTRA, this design series covers a wide range of applications.

FR Utilisation professionnelle : avec le POT FILLER pratique, la robinetterie PULL-DOWN ou la robinetterie Profi, TARA ULTRA couvre les domaines d'application les plus divers.

ES Uso profesional: con el práctico POT FILLER, la grifería PULL-DOWN o la grifería Profi, TARA ULTRA abarca los campos de aplicación más diversos.



For Professionals



limed douglas fir  
stainless steel  
travertine & silk  
bronze-tinted glass



# Materials





EN TARA ULTRA makes professional kitchen fittings available for private use: an exceptional portfolio of products is accompanied by a curated selection of individual finishes – from Chrome and Dark Chrome to Champagne (22kt gold).

FR TARA ULTRA propose des robinetteries de cuisine professionnelles pour les particuliers : outre la diversité particulière de l'assortiment, une sélection de finitions individuelles est disponible : du Chrome et Dark Chrome au Champagne (Or 22cts).

ES TARA ULTRA ofrece griferías de cocina profesionales para el ámbito privado: junto a la especial variedad de la gama, se ofrece una selección de acabados individuales: desde Cromo y Dark Chrome, hasta Champagne (Oro 22k).

# TARA ULTRA Selected Products

Product Information  
 Information sur les produits  
 Información de producto

<sup>EN</sup> Excerpt from the product range.  
 More detailed information can be obtained from your dealer. Due to the printing technique used here, the colours shown may vary from the true colour of the actual finish.

<sup>FR</sup> Extrait de notre gamme de produits.  
 Pour des informations complètes, veuillez vous adresser à votre commerçant. Du fait des procédés d'impression, les couleurs présentées ici sont sans engagement de notre part.

<sup>ES</sup> Extracto del programa de productos.  
 Si desea más información consulte con su comercio habitual. Los acabados reproducidos en el presente catálogo no son vinculantes por razones de impresión.

Finishes for fittings  
 Finitions robinetteries  
 Acabados grifería



00  
 Chrome  
 Chrome  
 Cromo



93  
 Brushed Chrome  
 Chrome brossé  
 Cromo cepillado

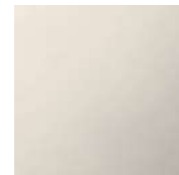

08  
 Platinum  
 Platine  
 Platino



06  
 Brushed Platinum  
 Platine brossé  
 Platino cepillado



47  
 Champagne (22kt Gold)  
 Champagne (Or 22cts)  
 Champagne (Oro 22k)



46  
 Brushed Champagne  
 (22kt Gold)  
 Champagne spazzolato  
 (Oro 22k)  
 Champagne cepillado  
 (Oro 22k)

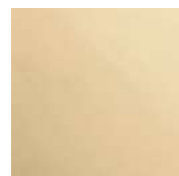

09  
 Durabass (23kt Gold)  
 Laiton (Or 23cts)  
 Latón (Oro 23k)



28  
 Brushed Durabass  
 (23kt Gold)  
 Laiton brossé (Or 23cts)  
 Latón cepillado (Oro 23k)



19  
 Dark Chrome  
 Dark Chrome  
 Dark Chrome



99  
 Brushed Dark Platinum  
 Dark Platinum brossé  
 Dark Platinum cepillado



33  
 Matte Black  
 Noir mat  
 Negro mate

Fittings  
 Robinetteries  
 Griferías



33 870 875  
 Single-lever mixer pull-down with spray function  
 Mitigeur monocommande Pull-down avec fonction douchette  
 Monomando Pull-down con función de chorro  
 [max. 1.5 gpm.]



33 816 875  
 Single-lever mixer  
 Mitigeur monocommande  
 Monomando  
 [max. 1.5 gpm]



33 860 875 <sup>a</sup>  
 Profi single-lever mixer  
 Mitigeur monocommande Profi  
 Monomando Profi  
 [max. 1.5 gpm]



33 826 875 + 27 721 970  
 Single-lever mixer with rinsing spray set  
 Mitigeur monocommande avec douchette extractible  
 Monomando con rociador de cocina  
 [max. 1.5 gpm]



17 861 875 <sup>b</sup>  
 HOT & COLD WATER DISPENSER  
 HOT & COLD WATER DISPENSER  
 HOT & COLD WATER DISPENSER  
 [max. 0.5 gpm]



33 826 875 + 27 789 970 <sup>a</sup>  
 Single-lever mixer with profi spray set  
 Mitigeur monocommande avec douchette pendulaire  
 Monomando con rociador de cocina profesional  
 [max. 1.5 gpm]



33 805 875  
 BAR TAP Single-lever mixer  
 BAR TAP Mitigeur monocommande  
 BAR TAP Monomando  
 [max. 1.5 gpm]



32 815 875  
 Two-hole mixer with individual flanges  
 Mitigeur à deux trous avec rosaces individuelles  
 Batería monomando de dos orificios con rosetas individuales  
 [max. 1.5 gpm]



33 800 875  
 Single-lever mixer  
 Mitigeur monocommande  
 Monomando  
 [max. 1.5 gpm]



32 815 875 + 27 731 970  
 Two-hole mixer with individual rosettes with rinsing spray set  
 Mitigeur à deux trous avec rosaces individuelles avec douchette extractible  
 Batería monomando de dos orificios con rosetas individuales con rociador de cocina  
 [max. 1.5 gpm]

<sup>a</sup> Item not available in finishes 47, 46, 09, 28 and 33. / Article non disponible dans les finitions 47, 46, 09, 28 et 33. / Artículo no disponible en los acabados 47, 46, 09, 28 y 33.

<sup>b</sup> You need the corresponding system components for this product. / Pour ce produit, vous avez besoin des composants système correspondants. / Para este producto necesita los componentes de sistema adecuados.

Fittings  
Robinetteries  
Griferías



32 815 875 + 27 799 970 <sup>c</sup>  
Two-hole mixer with individual rosettes with profi spray set  
Mitigeur à deux trous avec rosaces individuelles avec douchette pendulaire  
Batería monomando de dos orificios con rosetas individuales con rociador de cocina profesional  
[max. 1.5 gpm]



30 805 875 <sup>e</sup>  
POT FILLER Cold water valve  
POT FILLER robinet d'eau froide  
POT FILLER Válvula de agua fría  
[max. 1.5 gpm]



33 845 875 <sup>d</sup>  
PIVOT Single-lever mixer  
PIVOT Mitigeur monocommande  
PIVOT Monomando  
[max. 1.5 gpm]

Accessories  
Accessoires  
Complementos

DESIGN COLLECTIONS TARA ULTRA



10 712 970  
Strainer remote control with turning knob  
Commande de vidage individuelle manuelle Commande manuelle  
Accionamiento excéntrico manual con maneta de control giratoria



83 060 979 <sup>f</sup>  
Towel bar  
Porte-serviette de bain  
Barra colgador



83 251 220  
Hook  
Patère  
Gancho



83 080 979 <sup>f</sup>  
Towel bar  
Porte-serviette de bain  
Barra colgador

Accessories  
Accessoires  
Complementos



27 718 970 <sup>g</sup>  
27 713 970 <sup>h</sup>  
Side spray set  
Douchette extractible  
Rociador de cocina



10 713 970  
AIR SWITCH operating button, trim parts only  
AIR SWITCH bouton de commande de broyeur  
AIR SWITCH botón de manejo



82 424 970  
Soap dispenser without flange  
Distributeur sans rosace  
Dispenser sin rosetta



12 715 970  
Cover for tap hole  
Cache pour percement de robinetterie  
Tapón de orificio

Find out more about TARA ULTRA at  
Dornbracht/TARAULTRA.com



<sup>c</sup> Item not available in finishes 47, 46, 09, 28 and 33. / Article non disponible dans les finitions 47, 46, 09, 28 et 33. / Artículo no disponible en los acabados 47, 46, 09, 28 y 33.

<sup>d</sup> Item not available in finish 33. / Article non disponible dans la finition 33. / Artículo no disponible en el acabado 33.

<sup>e</sup> A rough parts kit is required for this article. Item not available in finish 33. / Un corps à encastrer est nécessaire pour l'installation de cet article. Article non disponible dans la finition 33. / Se requiere un kit de partes empotradas para este artículo. Artículo no disponible en el acabado 33.

<sup>f</sup> Item not available in finishes 08, 09 and 99. / Article non disponible dans les finitions 08, 09 et 99. / Artículo no disponible en los acabados 08, 09 y 99.

<sup>g</sup> can be used instead of 27 721 970

<sup>h</sup> can be used instead of 27 731 970





# LOT

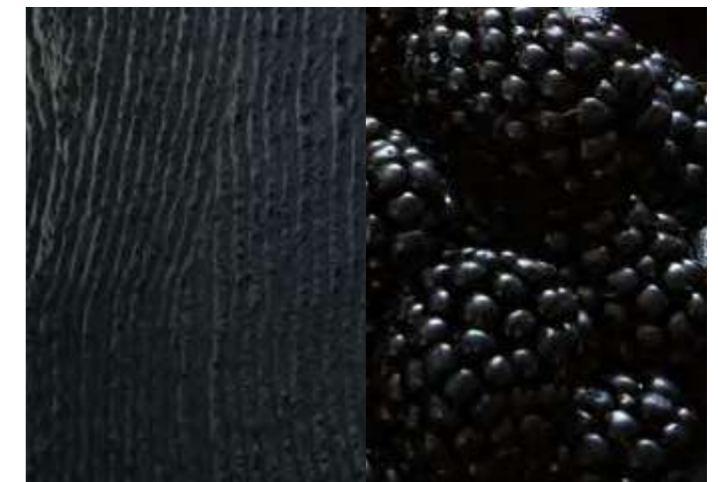

## The Architectural

**EN** LOT embodies architectural precision. Minimalist yet expressive. Its minimalist and sculpture-like design makes a striking statement in the kitchen.

**FR** LOT incarne la précision architecturale. Minimaliste, mais expressive. Sa forme réduite et sculpturale lui donne un style affirmé dans la cuisine.

**ES** LOT irradia precisión arquitectónica. Minimalista, pero expresiva. Su forma reducida y escultural constituye toda una declaración en la cocina.



LOT BRUSHED DARK PLATINUM

architectural  
sophisticated  
precise

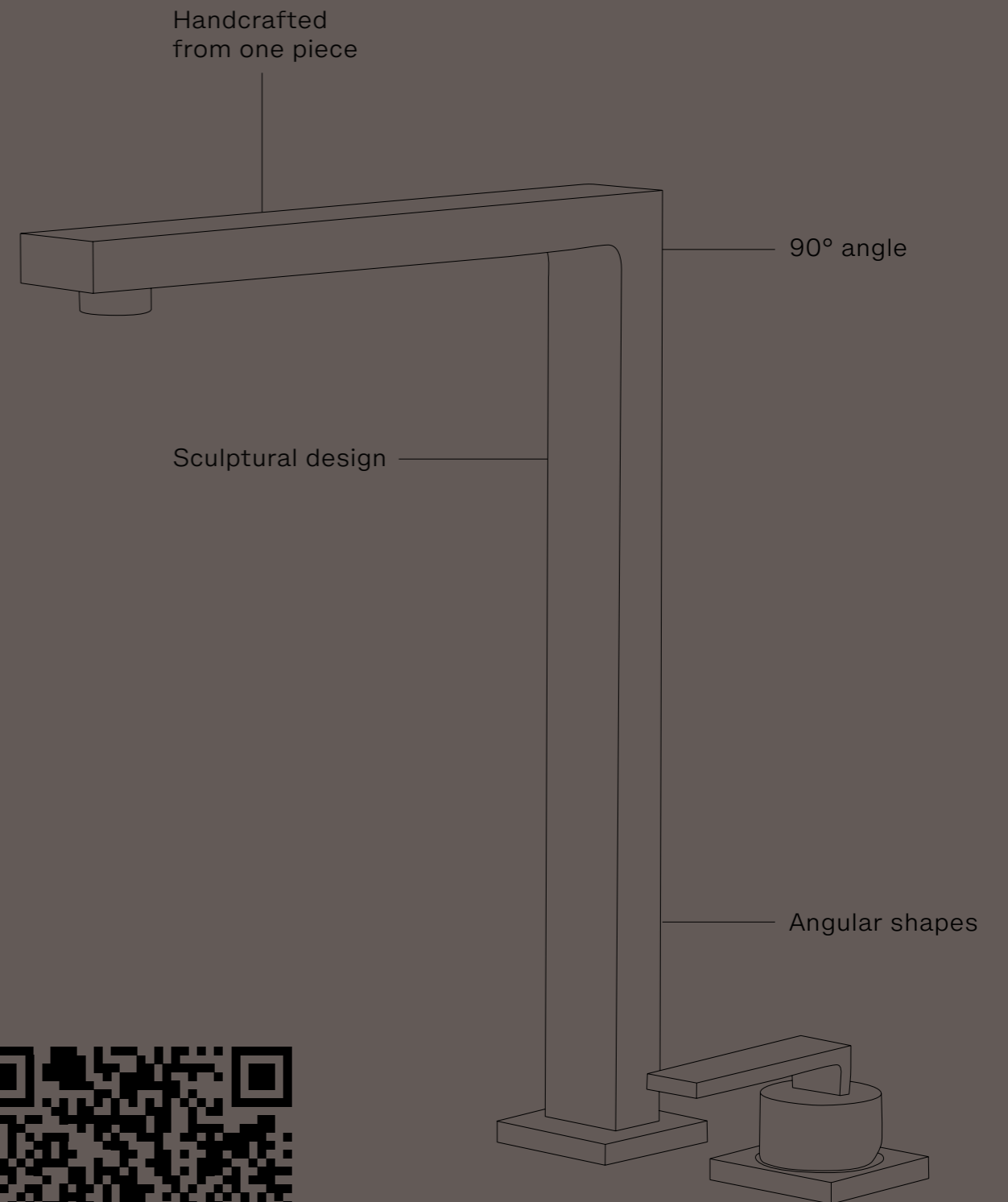

Find out more about LOT at [dornbracht.com/lot](http://dornbracht.com/lot)



## Layers of Black

<sup>EN</sup> A variety of nuances and textures in black create a minimalist, avant-garde setting in which LOT finds its place as a sculptural highlight.

<sup>FR</sup> Un'ampia varietà di sfumature e texture nere creano un ambiente minimalista-avanguardista in cui LOT, nella sua forma lineare, risalta e arricchisce l'ambiente.

<sup>ES</sup> Las tonalidades y las texturas más diversas en negro crean un entorno minimalista y vanguardista, en el que LOT encuentra su espacio como elemento estrella escultural.



<sup>EN</sup> LOT and the practical side sprayer set: aesthetics meet functional features for increased precision.

<sup>FR</sup> L'esthétique s'associe aux caractéristiques fonctionnelles pour un travail plus précis : LOT combinée à la douchette extractible maniable.

<sup>ES</sup> Estética y funcionalidad en pro de un uso más preciso: LOT combinado con el práctico juego de grifo de cocina.

# A Statement of Style



**EN** For kitchens with personality: the finish Platino accentuates the trend-setting design of LOT and adds an expressive touch.

**FR** Pour les cuisines qui ont de la personnalité : la finition Platine souligne le design au style marqué de LOT et crée un fort contraste.

**ES** Para cocinas con personalidad: el acabado Platino subraya el diseño que marca estilo de LOT y pone toques expresivos.



solid stone  
black stained oak  
black granite  
mirrored glass

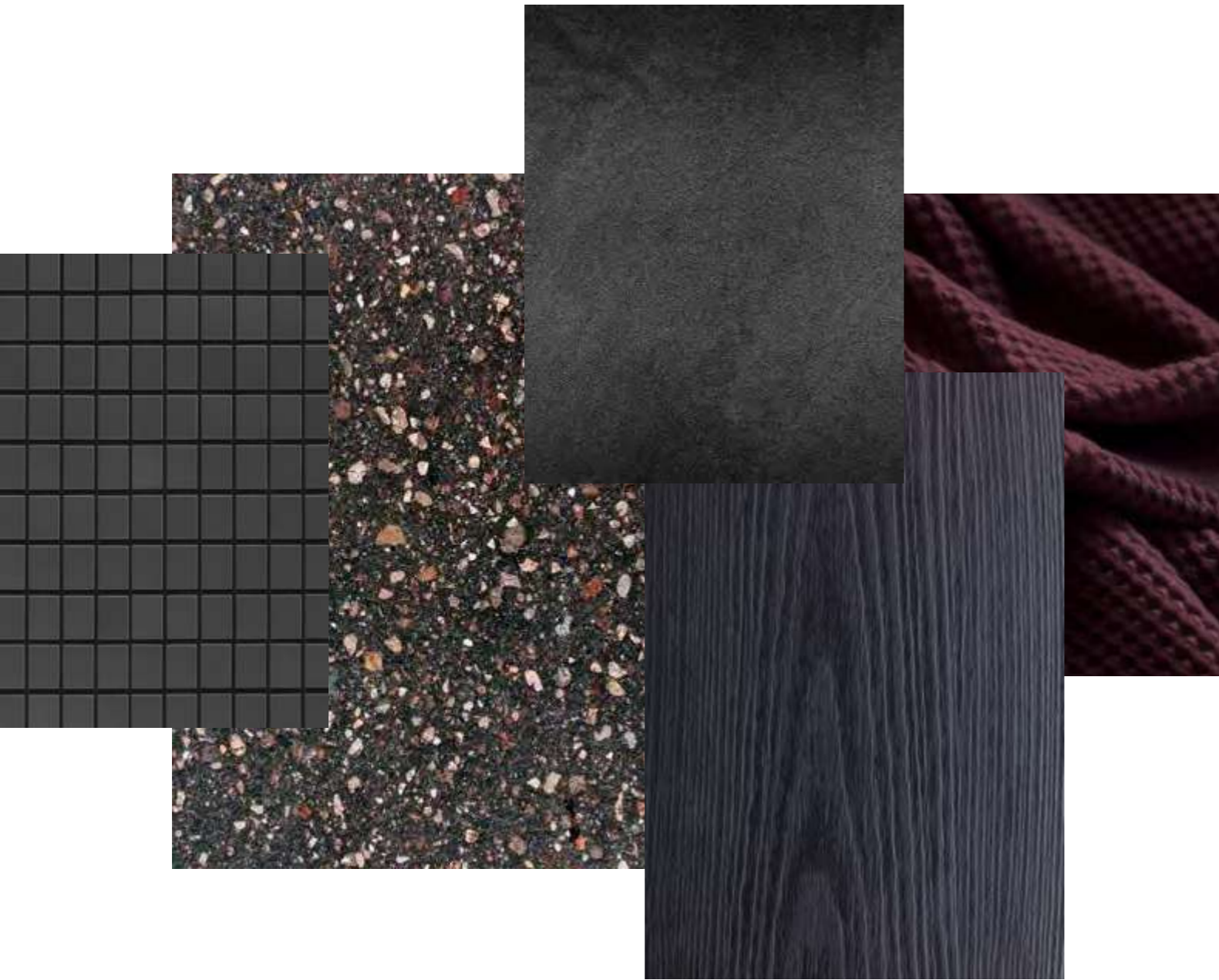

# Materials





**EN** Whether Brushed Platinum or Brushed Dark Platinum: LOT accentuates its surroundings not only with its sculptured design, but also with its variety of finishes, which can be integrated into various avant-garde interior styles.

**FR** Que ce soit en Platine brossé ou en Dark Platinum brossé, LOT accentue son environnement non seulement par sa forme sculpturale, mais aussi par la variété de ses finitions, qui s'intègrent dans des univers de style avant-gardistes.

**ES** Platino cepillado o Dark Platinum cepillado: LOT acentúa su entorno, no solo con su forma escultural, sino también con su gran variedad de acabados, que también puede integrarse en estilos vanguardistas.

# LOT Selected Products

Product Information  
 Information sur les produits  
 Información de producto

<sup>EN</sup> Excerpt from the product range.  
 More detailed information can be obtained from your dealer. Due to the printing technique used here, the colours shown may vary from the true colour of the actual finish.

<sup>FR</sup> Extrait de notre gamme de produits.  
 Pour des informations complètes, veuillez vous adresser à votre commerçant. Du fait des procédés d'impression, les couleurs présentées ici sont sans engagement de notre part.

<sup>ES</sup> Extracto del programa de productos.  
 Si desea más información consulte con su comercio habitual. Los acabados reproducidos en el presente catálogo no son vinculantes por razones de impresión.

Finishes for fittings  
 Finitions robinetteries  
 Acabados grifería



00  
 Chrome  
 Chrome  
 Cromo

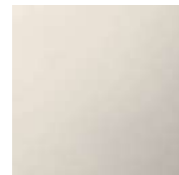

08  
 Platinum  
 Platine  
 Platino



06  
 Brushed Platinum  
 Platine brossé  
 Platino cepillado



47  
 Champagne (22kt Gold)  
 Champagne (Or 22cts)  
 Champagne (Oro 22k)



46  
 Brushed Champagne  
 (22kt Gold)  
 Champagne spazzolato  
 (Oro 22k)  
 Champagne cepillado  
 (Oro 22k)



28  
 Brushed Durabronze  
 (23kt Gold)  
 Laiton brossé (Or 23cts)  
 Latón cepillado (Oro 23k)



19  
 Dark Chrome  
 Dark Chrome  
 Dark Chrome



99  
 Brushed Dark Platinum  
 Dark Platinum brossé  
 Dark Platinum cepillado

Fittings  
 Robinetteries  
 Griferías

DESIGN COLLECTIONS LOT



17 861 680<sup>a</sup>  
 HOT & COLD WATER DISPENSER  
 HOT & COLD WATER DISPENSER  
 HOT & COLD WATER DISPENSER  
 [max. 0.5 gpm]



32 800 680  
 Two-hole mixer  
 with individual flanges  
 Mitigeur à deux trous avec rosaces  
 individuelles  
 Batería monomando de dos  
 orificios con rosetas individuales  
 [max. 1.5 gpm]



32 805 680  
 BAR TAP Two-hole mixer  
 with individual flanges  
 BAR TAP Mitigeur à deux trous  
 avec rosaces individuelles  
 BAR TAP Batería monomando de  
 dos orificios con rosetas individuales  
 [max. 1.5 gpm]



32 800 680 + 27 722 970  
 Two-hole mixer with individual  
 rosettes with rinsing spray set  
 Mitigeur à deux trous avec rosaces  
 individuelles avec douchette extractible  
 Batería monomando de dos  
 orificios con rosetas individuales  
 con rociador de cocina  
 [max. 1.5 gpm]



33 800 680  
 Single-lever mixer  
 Mitigeur monocommande  
 Monomando  
 [max. 1.5 gpm]



32 800 680 + 27 784 970<sup>b</sup>  
 Two-hole mixer with individual  
 rosettes with profi spray set  
 Mitigeur à deux trous avec rosaces  
 individuelles avec douchette pendulaire  
 Batería monomando de dos  
 orificios con rosetas individuales  
 con rociador de cocina profesional  
 [max. 1.5 gpm]



33 826 680 + 27 723 970  
 Single-lever mixer with  
 rinsing spray set  
 Mitigeur monocommande  
 avec douchette extractible  
 Monomando con rociador  
 de cocina  
 [max. 1.5 gpm]



32 843 680  
 Two-hole mixer with cover plate  
 Mitigeur à deux trous sur plaque  
 de recouvrement  
 Batería monomando de dos orificios  
 con cubierta  
 [max. 1.5 gpm]



33 826 680 + 27 785 970<sup>b</sup>  
 Single-lever mixer with  
 profi spray set  
 Mitigeur monocommande  
 avec douchette pendulaire  
 Monomando con rociador  
 de cocina profesional  
 [max. 1.5 gpm]



32 843 680 + 27 722 970  
 Two-hole mixer with cover plate  
 with rinsing spray set  
 Mitigeur à deux trous sur plaque de  
 recouvrement avec douchette extractible  
 Batería monomando de dos orificios  
 con cubierta con rociador de cocina  
 [max. 1.5 gpm]

<sup>a</sup> You need the corresponding system components for this product. / Pour ce produit, vous avez besoin des composants système correspondants. / Para este producto necesita los componentes de sistema adecuados.

<sup>b</sup> Item not available in finishes 47, 46 and 28. / Article non disponible dans les finitions 47, 46 et 28. / Artículo no disponible en los acabados 47, 46 y 28.

Fittings  
Robinetteries  
Griferías



32 843 680 + 27 784 970<sup>c</sup>  
Two-hole mixer with cover plate  
with profi spray set  
2-gats mengkraan met afdekplaat  
met profi-spoeldouche-garnituur  
Batería monomando de dos  
orificios con cubierta con rociador  
de cocina profesional  
[max. 1.5 gpm]

Accessories  
Accessoires  
Complementos



12 715 970  
Cover for tap hole  
Cache pour percement  
de robinetterie  
Tapón de orificio



83 251 780<sup>e</sup>  
Hook  
Patère  
Gancho



10 714 970<sup>d</sup>  
AIR SWITCH operating button,  
trim parts only  
AIR SWITCH bouton de commande  
de broyeur  
AIR SWITCH botón de manejo



83 045 670<sup>f</sup>  
Towel bar  
Porte-serviette de bain  
Barra colgador



10 711 970<sup>d</sup>  
Strainer remote control with  
turning knob  
Commande de vidage individuelle  
manuelle Commande manuelle  
Accionamiento excéntrico manual  
con maneta de control giratoria

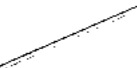

83 060 670<sup>f</sup>  
Towel bar  
Porte-serviette de bain  
Barra colgador



82 439 970<sup>d</sup>  
Soap dispenser with flange  
Distributeur avec rosace  
Dispensador con roseta

Find out more about LOT at  
Dornbracht/Lot.com



<sup>c</sup> Item not available in finishes 47, 46 and 28. / Article non disponible dans les finitions 47, 46 et 28. / Artículo no disponible en los acabados 47, 46 y 28.  
<sup>d</sup> Item not available in finish 33. / Article non disponible dans la finition 33. / Artículo no disponible en el acabado 33.  
<sup>e</sup> Item not available in finishes 93, 09 and 33. / Article non disponible dans les finitions 93, 09 et 33. / Artículo no disponible en los acabados 93, 09 y 33.  
<sup>f</sup> Item not available in finishes 08, 09, 28, 46, 47, 19, 99 and 33. / Article non disponible dans les finitions 08, 09, 28, 46, 47, 19, 99 et 33. / Artículo no disponible en los acabados 08, 09, 28, 46, 47, 19, 99 y 33.



# SYNC



**EN** SYNC combines progressive design with first-class performance. Thanks to its pull-out spout, the PULL-DOWN single-lever mixer increases your range of motion in the kitchen.

**FR** SYNC allie un design avant-gardiste à une excellente performance. Grâce à son bec extractible, le mitigeur mono-commande PULL-DOWN accroît le rayon d'action dans la cuisine.

**ES** SYNC fusiona diseño progresivo con un rendimiento de primera. Gracias a su caño extraíble, el mezclador monomando PULL-DOWN aumenta el radio de movimiento en la cocina.



The Progressive



SYNC MATTE BLACK

progressive  
dynamic  
performing

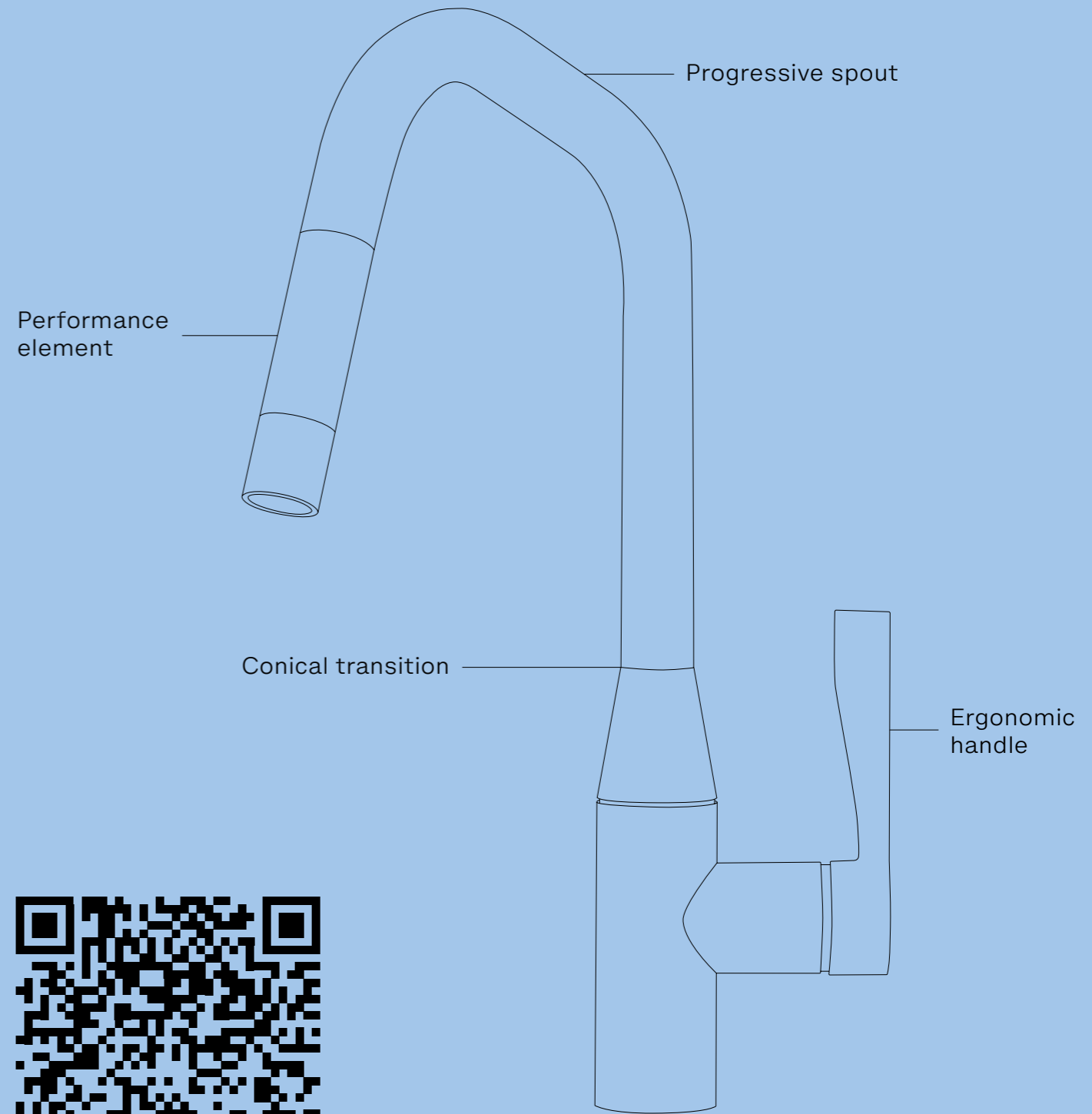

Find out more about SYNC at [dornbracht.com/sync](https://dornbracht.com/sync)



## Progressive Variety

**EN** SYNC offers a dynamic design for the professional kitchen in your own home. A progressive mix of different materials creates an unprecedented look.

**FR** Un design dynamique pour une cuisine professionnelle à domicile – voilà ce qu'offre SYNC. Un mélange avant-gardiste de différents matériaux crée un aspect inédit.

**ES** Un diseño dinámico para la cocina profesional en su propia casa: esto es lo que le ofrece SYNC. Una mezcla progresiva de diversos materiales crea un look nunca visto.





**EN** Practical for everyday use: SYNC Professional, with its flexible silicone hose, makes it easier to wash vegetables or dishes.

**FR** Pratique pour les tâches quotidiennes : la robinetterie Profi SYNC facilite le lavage des légumes ou la vaisselle grâce à son tuyau en silicone flexible.

**ES** Práctico en los movimientos cotidianos: la grifería Profi SYNC facilita, con su manguera de silicona flexible, el lavado de verduras o vajilla.

# Cooking Enthusiasm



**EN** Precise and spot-on: the PULL-DOWN single-lever mixer with shower function can be swiveled in a 360° radius and switched from a laminar stream to a shower spray.

**FR** Une précision absolue : le mitigeur monocommande PULL-DOWN avec fonction douchette est orientable à 360° et peut passer du jet laminaire au jet douchette selon les besoins.

**ES** Gran precisión: el mezclador monomando PULL-DOWN con función de ducha rociadora puede girarse en un radio de 360° y, según las necesidades, puede variar de chorro laminaire a chorro de ducha.



sustainable fabric  
copper & terrazzo  
bianco carrara marble  
slate stone

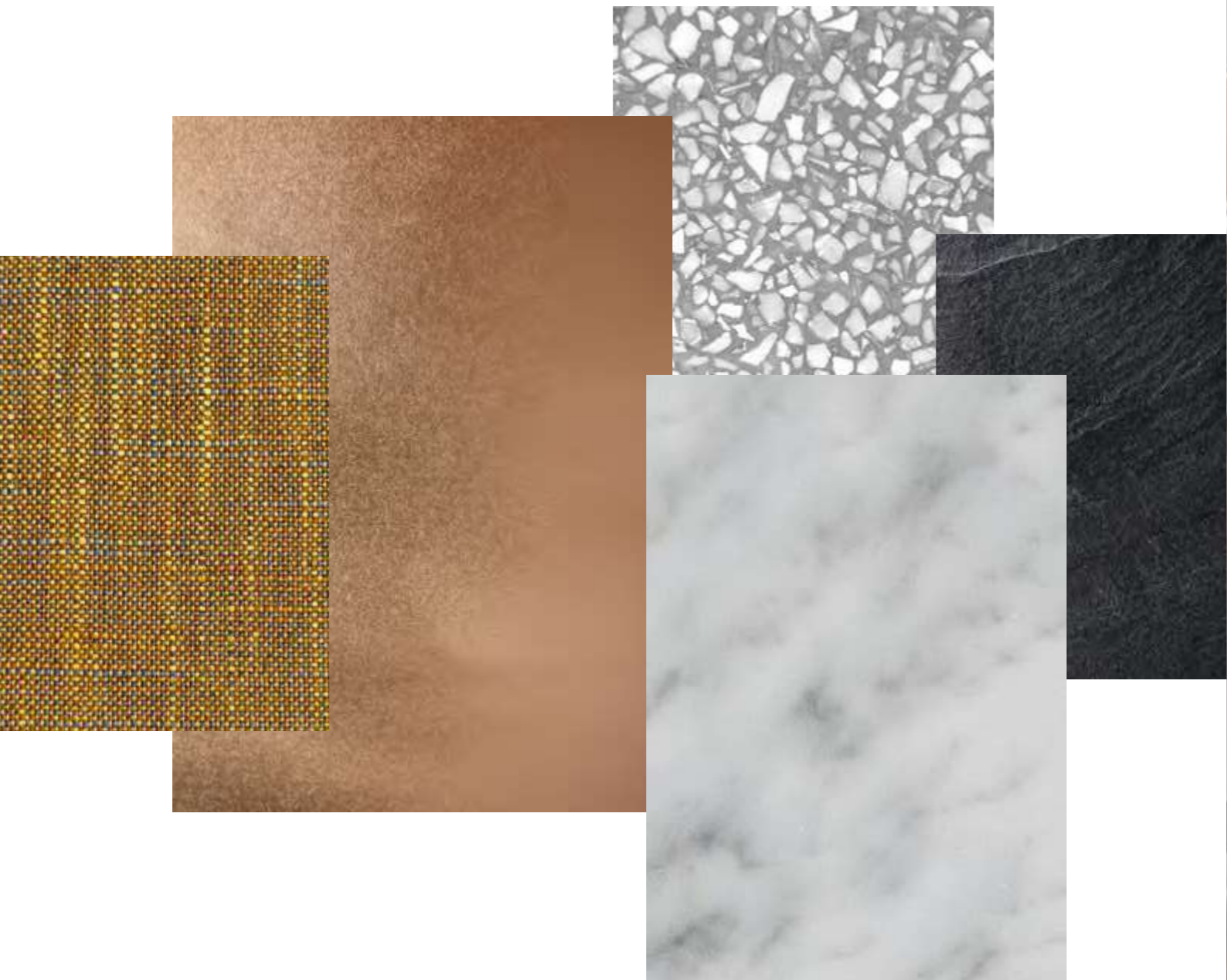

# Materials



EN SYNC fits seamlessly into progressive kitchens with its dynamic character, featuring a wide range of functions that include the PULL-DOWN fitting with its shower spray function, the SYNC professional fitting, and a matching detergent dispenser.

FR Avec son caractère dynamique, SYNC s'intègre dans des univers de cuisine avant-gardistes et offre de multiples applications pour votre cuisine : de la robinetterie PULL-DOWN avec fonction douchette à la robinetterie Profi, y compris le distributeur de produit vaisselle assorti.

ES Con su carácter dinámico, SYNC se integra en mundos de cocina progresivos y ofrece, desde la grifería PULL-DOWN con función de ducha rociadora hasta la grifería Profi, las más diversas aplicaciones para su cocina: incluyendo un dispensador de detergente apropiado.



# SYNC Selected Products

Product Information  
 Information sur les produits  
 Información de producto

<sup>EN</sup> Excerpt from the product range.  
 More detailed information can be obtained from your dealer. Due to the printing technique used here, the colours shown may vary from the true colour of the actual finish.

<sup>FR</sup> Extrait de notre gamme de produits.  
 Pour des informations complètes, veuillez vous adresser à votre commerçant. Du fait des procédés d'impression, les couleurs présentées ici sont sans engagement de notre part.

<sup>ES</sup> Extracto del programa de productos.  
 Si desea más información consulte con su comercio habitual. Los acabados reproducidos en el presente catálogo no son vinculantes por razones de impresión.

Finishes for fittings  
 Finitions robinetteries  
 Acabados grifería



00  
 Chrome  
 Chrome  
 Cromo



93  
 Brushed Chrome  
 Chrome brossé  
 Cromo cepillado

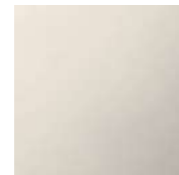

08  
 Platinum  
 Platine  
 Platino



06  
 Brushed Platinum  
 Platine brossé  
 Platino cepillado



47  
 Champagne (22kt Gold)  
 Champagne (Or 22cts)  
 Champagne (Oro 22k)



46  
 Brushed Champagne  
 (22kt Gold)  
 Champagne spazzolato  
 (Oro 22k)  
 Champagne cepillado  
 (Oro 22k)

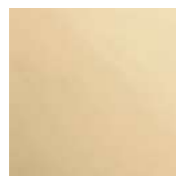

09  
 Durabass (23kt Gold)  
 Laiton (Or 23cts)  
 Latón (Oro 23k)



28  
 Brushed Durabass  
 (23kt Gold)  
 Laiton brossé (Or 23cts)  
 Latón cepillado (Oro 23k)



19  
 Dark Chrome  
 Dark Chrome  
 Dark Chrome

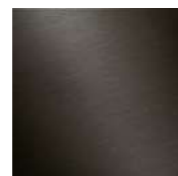

99  
 Brushed Dark Platinum  
 Dark Platinum brossé  
 Dark Platinum cepillado



33  
 Matte Black  
 Noir mat  
 Negro mate

Fittings  
 Robinetteries  
 Griferías



33 875 895  
 Single-lever mixer pull-down  
 with spray function  
 Mitigeur monocommande  
 Pull-down avec fonction douchette  
 Monomando Pull-down con  
 función de chorro  
 [max. 1.5 gpm]



33 870 895  
 Single-lever mixer pull-down  
 with spray function  
 Mitigeur monocommande  
 Pull-down avec fonction douchette  
 Monomando Pull-down con  
 función de chorro  
 [max. 1.5 gpm]



33 865 895  
 Profi single-lever mixer  
 Mitigeur monocommande Profi  
 Monomando  
 [max. 1.5 gpm]



30 805 875 <sup>a</sup>  
 POT FILLER Cold water valve  
 POT FILLER robinet d'eau froide  
 POT FILLER Válvula de agua fría  
 [max. 1.5 gpm]

<sup>a</sup> A rough parts kit is required for this article. Item not available in finish 33. / Un corps à encastrer est nécessaire pour l'installation de cet article. Article non disponible dans la finition 33. / Se requiere un kit de partes empotradas para este artículo. Artículo no disponible en el acabado 33.

Accessories  
Accessoires  
Complementos



82 424 970  
Soap dispenser without flange  
Distributeur sans rosace  
Dispensador sin roseta

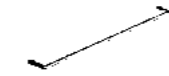

83 060 979<sup>b</sup>  
Towel bar  
Porte-serviette de bain  
Barra colgador



10 713 970  
AIR SWITCH operating button,  
trim parts only  
AIR SWITCH bouton de  
commande de broyeur  
AIR SWITCH botón de manejo



83 080 979<sup>b</sup>  
Towel bar  
Porte-serviette de bain  
Barra colgador



10 712 970  
Strainer remote control with  
turning knob  
Commande de vidage  
individuelle manuelle  
Commande manuelle  
Accionamiento excéntrico manual  
con maneta de control giratoria



12 715 970  
Cover for tap hole  
Cache pour percement  
de robinetterie  
Tapón de orificio



83 251 220  
Hook  
Patère  
Gancho

Find out more about SYNC at  
[Dornbracht/Sync.com](https://www.dornbracht.com/sync)





# ELIO







**EN** The subtle yet pragmatic design of ELIO makes it particularly versatile. A universal style that fits into simple, functional kitchens.

**FR** Son design à la fois discret et pragmatique rend ELIO particulièrement adaptable. Une forme universelle qui s'adapte aux cuisines sobres et fonctionnelles.

**ES** Su diseño sobrio y al mismo tiempo pragmático logra que ELIO se adapte a todo. Una forma universal que encaja en cocinas funcionales y sobrias.



The Casual



ELIO BRUSHED CHROME

casual  
flexible  
pragmatic

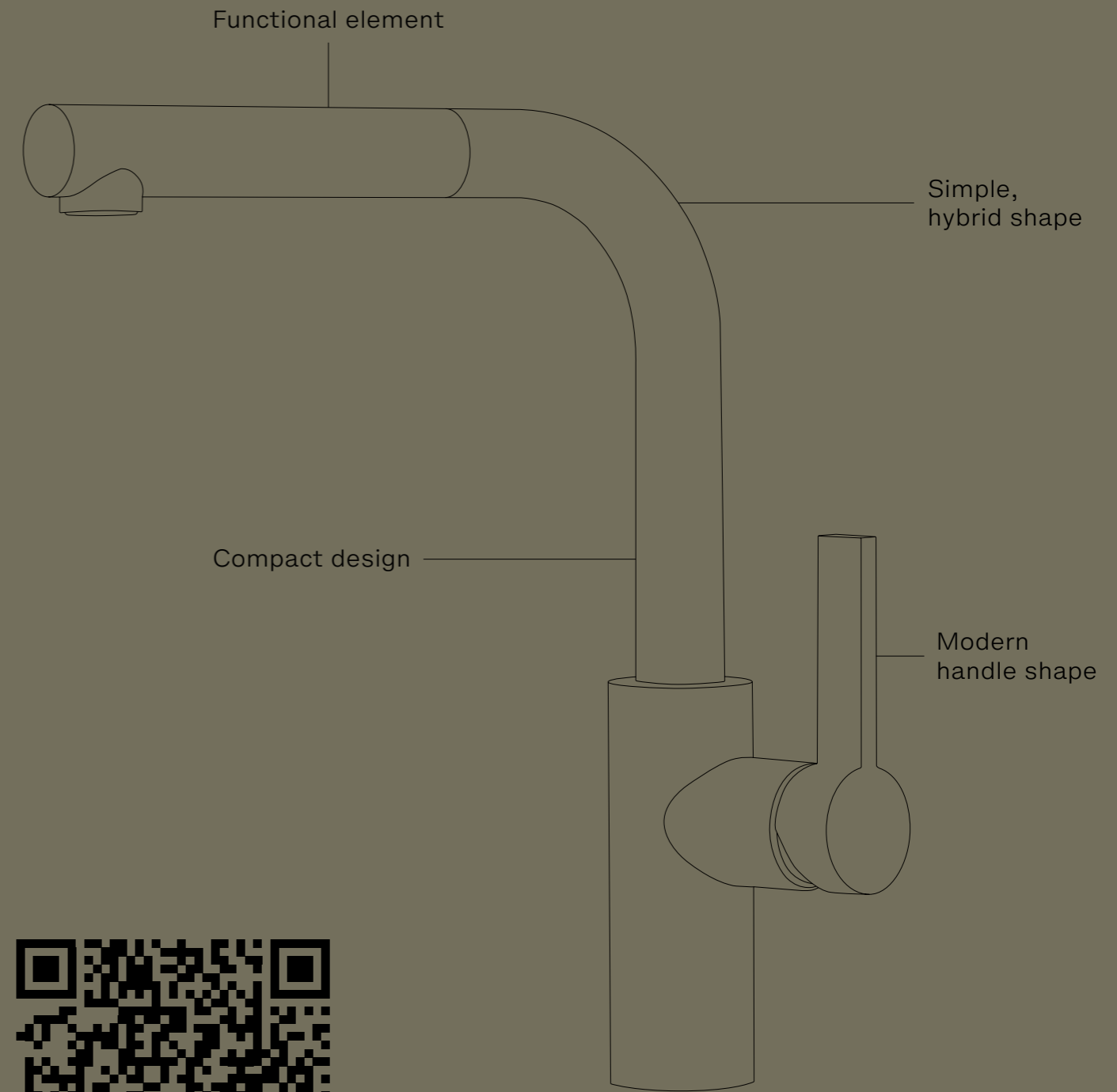



## Flowing Brightness

**EN** Stylish, harmonious, dynamic: rounded lines define the aesthetics of ELIO. They translate into an ergonomic design that makes daily activities in the kitchen easier.

**FR** Stylée, harmonieuse, dynamique : des formes rondes déterminent l'apparence d'ELIO. Elles se traduisent par un design ergonomique qui facilite les gestes quotidiens dans la cuisine.

**ES** Con estilo, armonía y dinamismo: las formas redondas determinan el aspecto de ELIO. Se plasman en un diseño ergonómico que facilita los movimientos cotidianos en la cocina.



<sup>EN</sup> Whether washing dishes or rinsing vegetables – ELIO in Chrome offers superior flexibility with its pull-out spout.

<sup>FR</sup> Que ce soit pour faire la vaisselle ou laver les légumes, ELIO en Chrome garantit une utilisation flexible grâce à son bec extractible.

<sup>ES</sup> Al lavar los platos o la verdura: ELIO en Cromo ofrece un manejo flexible gracias a su caño de salida extraíble.



Work With  
the Flow

**EN** With its PULL-OUT function, this fitting provides you with greater versatility and significantly extends the work area. The HOT & COLD WATER DISPENSER is another practical feature.

**FR** Avec la fonction PULL-OUT, la robinetterie est adaptable et facilement extensible à la zone de travail. Le HOT & COLD WATER DISPENSER est également pratique.

**ES** Con la función PULL-OUT la grifería tiene una gran capacidad de adaptación y puede extenderse sobre el área de trabajo. HOT & COLD WATER DISPENSER también resulta especialmente práctico.



linen & cotton  
glass tiles  
wooden slats  
concrete & terrazzo



# Materials



# ELIO Selected Products

**EN** ELIO masters any challenge, and makes working in the kitchen an uncomplicated task. The series offers you a variety of finishes and possible applications, and includes an optional pull-out element.

**FR** ELIO relève tous les défis pour un travail simple en cuisine. La série vous offre une multitude de finitions et d'applications possibles, au choix avec élément extractible.

**ES** ELIO supera todos los retos: para trabajar sin complicaciones en la cocina. La serie le ofrece una gran variedad de acabados y posibilidades de uso: opcionalmente con un elemento extraíble.

Product Information  
 Information sur les produits  
 Información de producto

<sup>EN</sup> Excerpt from the product range.  
 More detailed information can be obtained from your dealer. Due to the printing technique used here, the colours shown may vary from the true colour of the actual finish.

<sup>FR</sup> Extrait de notre gamme de produits.  
 Pour des informations complètes, veuillez vous adresser à votre commerçant. Du fait des procédés d'impression, les couleurs présentées ici sont sans engagement de notre part.

<sup>ES</sup> Extracto del programa de productos.  
 Si desea más información consulte con su comercio habitual. Los acabados reproducidos en el presente catálogo no son vinculantes por razones de impresión.

Finishes for fittings  
 Finitions robinetteries  
 Acabados grifería



00  
 Chrome  
 Chrome  
 Cromo



93  
 Brushed Chrome  
 Chrome brossé  
 Cromo cepillado

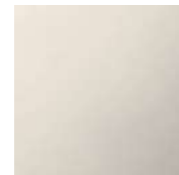

08  
 Platinum  
 Platine  
 Platino



06  
 Brushed Platinum  
 Platine brossé  
 Platino cepillado



47  
 Champagne (22kt Gold)  
 Champagne (Or 22cts)  
 Champagne (Oro 22k)



46  
 Brushed Champagne  
 (22kt Gold)  
 Champagne spazzolato  
 (Oro 22k)  
 Champagne cepillado  
 (Oro 22k)

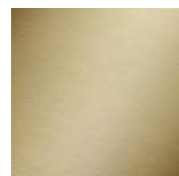

28  
 Brushed Durabronze  
 (23kt Gold)  
 Laiton brossé (Or 23cts)  
 Latón cepillado (Oro 23k)



19  
 Dark Chrome  
 Dark Chrome  
 Dark Chrome

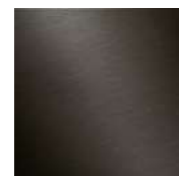

99  
 Brushed Dark Platinum  
 Dark Platinum brossé  
 Dark Platinum cepillado

Fittings  
 Robinetteries  
 Griferías



33 870 790  
 Single-lever mixer with spray function  
 Eengreepsmengkraan met uittrekbare uitloop met sproeifunctie  
 Monomando Pull-out con función de chorro  
 [max. 1.5 gpm]



32 800 790  
 Two-hole mixer with individual flanges  
 Mitigeur à deux trous avec rosaces individuelles  
 Batería monomando de dos orificios con rosetas individuales  
 [max. 1.5 gpm]



33 840 790  
 Single-lever mixer pull-out  
 Mitigeur monocommande Pull-out  
 Monomando Pull-out  
 [max. 1.5 gpm]



32 800 790 + 27 721 970  
 Two-hole mixer with individual rosettes with rinsing spray set  
 Mitigeur à deux trous avec rosaces individuelles avec douchette extractible  
 Batería monomando de dos orificios con rosetas individuales con rociador de cocina  
 [max. 1.5 gpm]



17 861 790<sup>a</sup>  
 HOT & COLD WATER DISPENSER  
 HOT & COLD WATER DISPENSER  
 HOT & COLD WATER DISPENSER  
 [max. 0.5 gpm]



32 800 790 + 27 789 970<sup>b</sup>  
 Two-hole mixer with individual rosettes with profi spray set  
 Mitigeur à deux trous avec rosaces individuelles avec douchette pendulaire  
 Batería monomando de dos orificios con rosetas individuales con rociador de cocina profesional  
 [max. 1.5 gpm]



33 800 790  
 Single-lever mixer  
 Mitigeur monocommande  
 Monomando  
 [max. 1.5 gpm]



30 805 875<sup>c</sup>  
 POT FILLER Cold water valve  
 POT FILLER robinet d'eau froide  
 POT FILLER Válvula de agua fría  
 [max. 1.5 gpm]

<sup>a</sup> You need the corresponding system components for this product. / Pour ce produit, vous avez besoin des composants système correspondants. / Para este producto necesita los componentes de sistema adecuados.  
<sup>b</sup> Item not available in finishes 47, 46 and 28. / Article non disponible dans les finitions 47, 46 et 28. / Artículo no disponible en los acabados 47, 46 y 28.  
<sup>c</sup> A rough parts kit is required for this article. Artikel is niet beschikbaar in het oppervlak 33. / Un corps à encastrer est nécessaire pour l'installation de cet article. Article non disponible dans la finition 33 / Se requiere un kit de partes empotradas para este artículo. Artículo no disponible en el acabado 33.





27 718 970  
Side spray set  
Douchette extractible  
Rociador de cocina



83 251 220  
Hook  
Patère  
Gancho



82 424 970  
Soap dispenser without flange  
Distributeur sans rosace  
Dispensador sin roseta



83 060 979<sup>d</sup>  
Towel bar  
Porte-serviette de bain  
Barra colgador



10 713 970  
AIR SWITCH operating button,  
trim parts only  
AIR SWITCH bouton de  
commande de broyeur  
AIR SWITCH botón de manejo



83 080 979<sup>d</sup>  
Towel bar  
Porte-serviette de bain  
Barra colgador



10 712 970  
Strainer remote control with  
turning knob  
Commande de vidage individuelle  
manuelle Commande manuelle  
Accionamiento excéntrico manual  
con maneta de control giratoria



12 715 970  
Cover for tap hole  
Cache pour percement  
de robinetterie  
Tapón de orificio

Find out more about ELIO at  
[Dornbracht/Elío.com](https://www.dornbracht.com/elio)





# ENO



EN The design of ENO is subtle and down-to-earth, yet smart in its details. Its cold-start function facilitates economical hot water consumption and its compact design enables a wide range of applications even in small spaces.

FR Le design d'ENO est sobre et discret, mais pourvu de détails intelligents. Grâce à la fonction de démarrage à froid, elle favorise une faible consommation d'eau chaude et, avec sa forme compacte, elle répond à de multiples exigences, même dans un espace réduit.

ES El diseño de ENO es sobrio y discreto, pero con detalles inteligentes. Con su función de inicio frío, fomenta un consumo reducido del agua caliente. Con su forma compacta, es capaz de colmar grandes exigencias en espacios reducidos.



The Conscious



ENO CHROME

smart  
intuitive  
simple

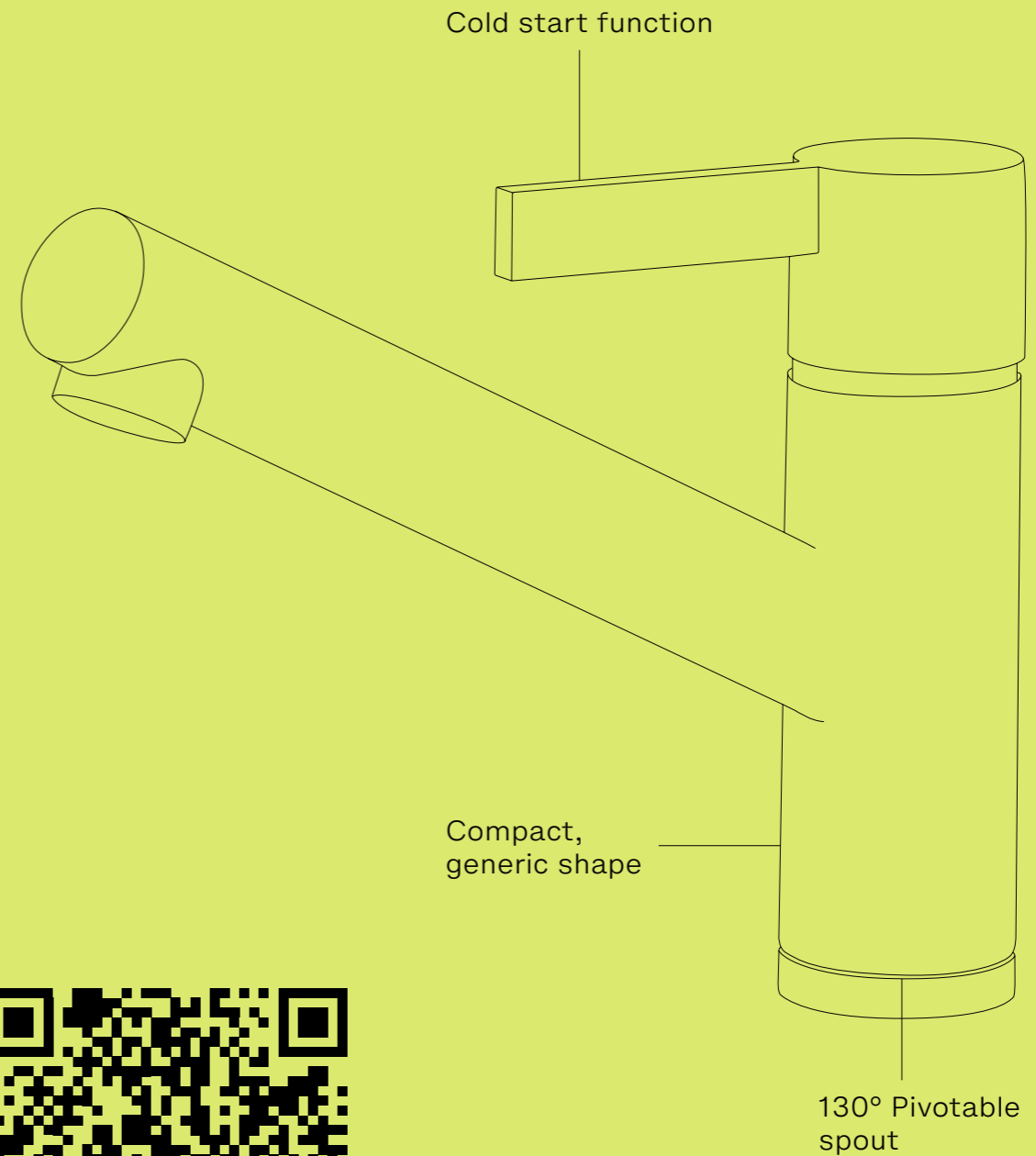

Find out more about ENO at [dornbracht.com/en0](http://dornbracht.com/en0)



## Conscious Simplicity

**EN** Practical in design and smart in function, ENO fits perfectly into smaller kitchens: thanks to its compact and ergonomic shape, it fits perfectly under hanging cabinets.

**FR** Avec son design sobre et sa fonction intelligente, ENO s'intègre parfaitement dans les petites cuisines : grâce à sa forme compacte et ergonomique, elle trouve idéalement sa place sous des placards suspendus.

**ES** De diseño sobrio y funcionalidad inteligente, ENO se integra perfectamente en cocinas de pequeñas dimensiones: gracias a su forma compacta y ergonómica, todo encuentra su espacio bajo los armarios suspendidos.



<sup>EN</sup> Only cold water flows in the neutral lever position, which ensures that ENO's lever concept intuitively helps to reduce hot water consumption.

<sup>FR</sup> Seule de l'eau froide s'écoule lorsque la poignée se trouve en position neutre. De cette manière, la poignée d'ENO aide intuitivement à réduire la consommation d'eau chaude.

<sup>ES</sup> En posición de palanca neutral, se obtiene solo agua fría, por lo que el concepto de palanca de ENO ayuda intuitivamente a reducir el consumo de agua caliente.



## Functional Flexibility

**EN** With its different versions and functions, ENO is the ideal fitting for small, urban kitchens. In addition to the classic single-lever mixer, ENO is available as a PULL-OUT fitting with PULL-OUT sprayer or PULL-OUT spout.

**FR** Avec ses diverses variantes fonctionnelles, ENO est la robinetterie idéale pour les petites cuisines urbaines. Outre le mitigeur monocommande classique, la robinetterie ENO est disponible en version PULL-OUT avec douchette ou bec extractible.

**ES** Con sus diferentes variantes funcionales, ENO es la grifería ideal para las pequeñas cocinas urbanas. Además de la clásica de mezclador monomando, ENO también está disponible como grifería PULL-OUT con grifo extraíble o caño de salida extraíble.



dark slate  
stainless steel  
grey terrazzo  
shapes and colours



# Materials



<sup>EN</sup> With distinctive finishes ranging from Chrome and Brushed Dark Platinum to Brushed Durabronze (23kt Gold), ENO offers an inspiring selection of fitting arrangements and kitchen accessories for different interior styles.

<sup>FR</sup> Avec des finitions individuelles allant du Chrome au Laiton brossé (Or 23cts) en passant par le Dark Platinum brossé, ENO propose un choix inspirant pour différents univers de style, en plus des accessoires pour votre cuisine.

<sup>ES</sup> Con acabados individuales desde Cromo, Dark Platinum cepillado hasta Latón cepillado (Oro 23k), ENO ofrece una selección inspiradora para diversos estilos: además de complementos para su cocina.



# ENO Selected Products

Product Information  
 Information sur les produits  
 Información de producto

<sup>EN</sup> Excerpt from the product range.  
 More detailed information can be obtained from your dealer. Due to the printing technique used here, the colours shown may vary from the true colour of the actual finish.

<sup>FR</sup> Extrait de notre gamme de produits.  
 Pour des informations complètes, veuillez vous adresser à votre commerçant. Du fait des procédés d'impression, les couleurs présentées ici sont sans engagement de notre part.

<sup>ES</sup> Extracto del programa de productos.  
 Si desea más información consulte con su comercio habitual. Los acabados reproducidos en el presente catálogo no son vinculantes por razones de impresión.

Finishes for fittings  
 Finitions robinetteries  
 Acabados grifería



00  
 Chrome  
 Chrome  
 Cromo



93  
 Brushed Chrome  
 Chrome brossé  
 Cromo cepillado

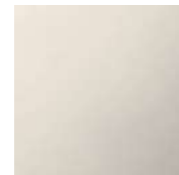

08  
 Platinum  
 Platine  
 Platino



06  
 Brushed Platinum  
 Platine brossé  
 Platino cepillado



47  
 Champagne (22kt Gold)  
 Champagne (Or 22cts)  
 Champagne (Oro 22k)



46  
 Brushed Champagne  
 (22kt Gold)  
 Champagne spazzolato  
 (Oro 22k)  
 Champagne cepillado  
 (Oro 22k)



28  
 Brushed Durabronze  
 (23kt Gold)  
 Laiton brossé (Or 23cts)  
 Latón cepillado (Oro 23k)



19  
 Dark Chrome  
 Dark Chrome  
 Dark Chrome



99  
 Brushed Dark Platinum  
 Dark Platinum brossé  
 Dark Platinum cepillado

Fittings  
 Robinetteries  
 Griferías



33 870 760  
 Single-lever mixer pull-out with spray function  
 Mitigeur monocommande Pull-out avec fonction douchette  
 Monomando Pull-out con función de chorro  
 [max. 1.5 gpm]

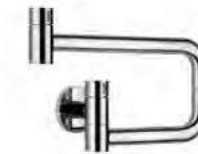

30 805 875 <sup>a</sup>  
 POT FILLER Cold water valve  
 POT FILLER robinet d'eau froide  
 POT FILLER Válvula de agua fría  
 [max. 1.5 gpm]



33 875 760  
 Single-lever mixer pull-out with spray function  
 Mitigeur monocommande Pull-out avec fonction douchette  
 Monomando Pull-out con función de chorro  
 [max. 1.5 gpm]



33 800 760  
 Single-lever mixer  
 Mitigeur monocommande  
 Monomando  
 [max. 1.5 gpm]

<sup>a</sup> A rough parts kit is required for this article. Item not available in finish 33. / Un corps à encastrer est nécessaire pour l'installation de cet article. Article non disponible dans la finition 33. / Se requiere un kit de partes empotradas para este artículo. Artículo no disponible en el acabado 33.

Accessories  
Accessoires  
Complementos



82 424 970  
Soap dispenser without flange  
Distributeur sans rosace  
Dispensador sin roseta



83 060 979<sup>Ⓟ</sup>  
Towel bar  
Porte-serviette de bain  
Barra colgador



10 713 970  
AIR SWITCH operating button,  
trim parts only  
AIR SWITCH bouton de  
commande de broyeur  
AIR SWITCH botón de manejo



83 080 979<sup>Ⓟ</sup>  
Towel bar  
Porte-serviette de bain  
Barra colgador



10 712 970  
Strainer remote control with  
turning knob  
Commande de vidage individuelle  
manuelle Commande manuelle  
Accionamiento excéntrico manual  
con maneta de control giratoria



12 715 970  
Cover for tap hole  
Cache pour percement  
de robinetterie  
Tapón de orificio



83 251 220  
Hook  
Patère  
Gancho

Find out more about ENO at  
[Dornbracht/Eno.com](http://Dornbracht/Eno.com)







x-tra Service

Unique  
Solutions

# Everything Starts With Your Idea

**EN** Anything is possible with Dornbracht x-tra Service: together we can transform your ideas for the kitchen into reality – tailored to your needs and with the utmost attention to detail. There are virtually no limits to your creativity: the possibilities range from individual finishes and structures to refinement with materials of your choice. Feel free to contact us! Our x-tra Service team is looking forward to working with you and your ideas.

**FR** Tout est possible avec le Dornbracht x-tra Service : ensemble, nous réalisons votre vision pour votre cuisine et vous proposons des solutions sur mesure, tout en accordant la plus grande attention aux détails. L'imagination ne connaît pratiquement aucune limite : les possibilités vont des finitions et structures individuelles aux ennoblisements avec le matériau de votre choix. N'hésitez pas à nous contacter ! Notre équipe x-tra Service vous répondra volontiers et attend vos idées avec impatience.

**ES** Con x-tra Service de Dornbracht, todo es posible: juntos plasmamos la cocina de sus sueños – a medida, y con un gran mimo por los detalles. Y apenas ponemos límite a la fantasía: las posibilidades abarcan desde acabados y estructuras individuales hasta refinamientos con el material que desee. ¡Póngase en contacto con nosotros! Nuestro equipo x-tra Service estará encantado de atenderle y conocer sus ideas.



Find out more about our customization services on [dornbracht.com/xtra-service-contact](https://dornbracht.com/xtra-service-contact)

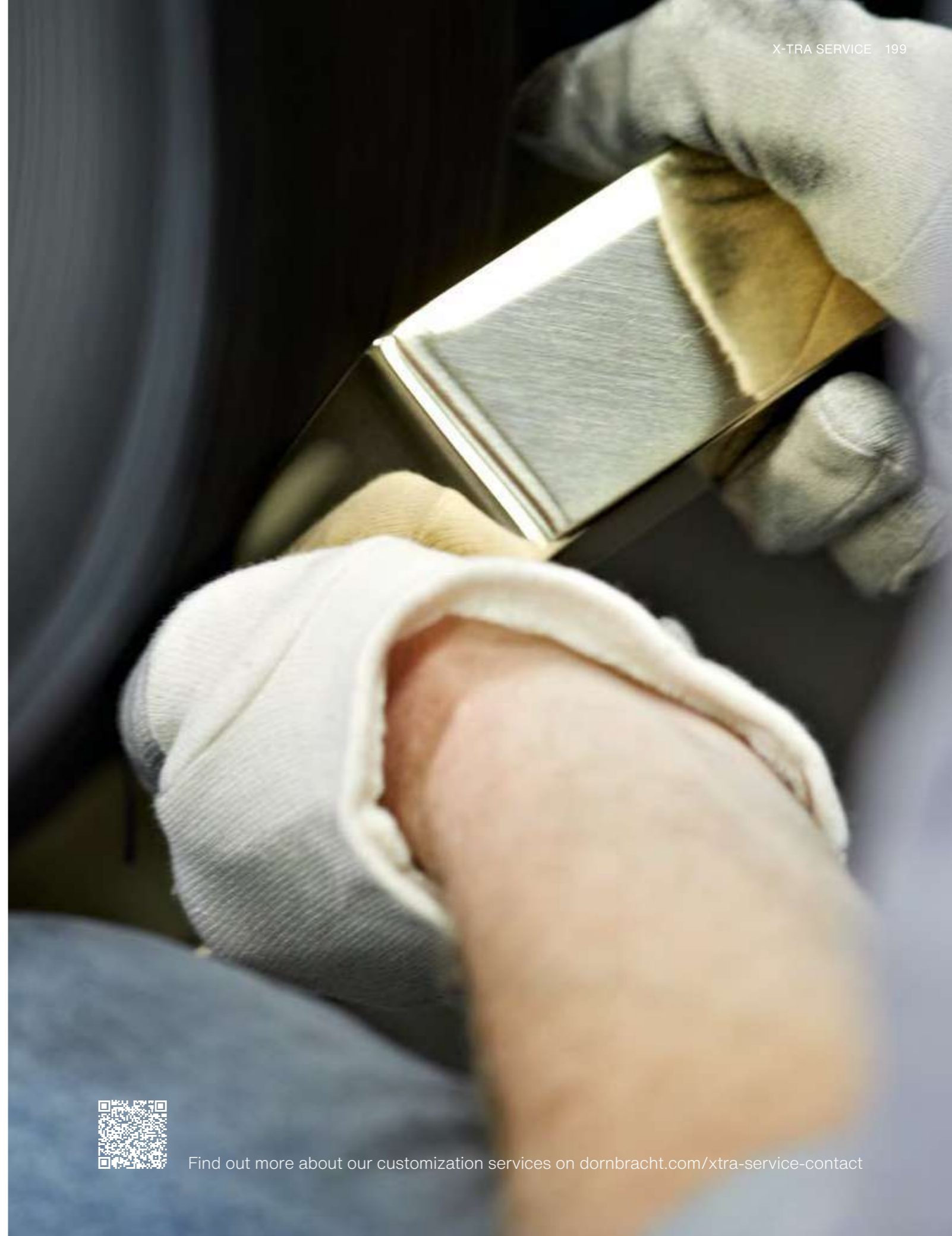



Sustainability

A Question  
of Attitude



# Sustainability: Our Contribution

<sup>EN</sup> Sustainability has been our vision and our conviction from the very beginning. It's an attitude that influences every decision we make about quality, materials, manufacturing processes and suppliers. As signatories of the UN Sustainable Development Goals, Dornbracht is committed to durable products and designs that last. We are also committed to sustainable manufacturing and the responsible use of our products. One example of this commitment is our extensive repair and refurbishment service. We have been producing and selling climate-neutral products since 2021. Dornbracht's goal of increasing its contribution to climate change mitigation means that we are dedicated to continuously improving our energy and resource efficiency through innovative products and solutions. In recent years, an example of meeting our goals is the significant reduction of water consumption by our fittings and rain showers.

<sup>FR</sup> L'ambition et la conviction d'agir durablement nous accompagnent depuis le début. Une attitude qui influence chaque décision concernant la qualité, les matériaux, les processus de fabrication et les fournisseurs. En tant que signataire des objectifs de développement durable de l'ONU, nous allons, chez Dornbracht, au-delà de notre engagement pour des produits et des designs qui durent. Nous nous engageons aussi pour une production durable et une utilisation responsable de nos produits, notamment grâce à notre service complet de réparation et de remise à neuf. Depuis 2021, notre production et notre distribution sont neutres pour le climat. Afin d'augmenter encore

notre contribution à la protection du climat, nous améliorons continuellement notre efficacité dans l'utilisation de l'énergie et des ressources grâce à des produits et des solutions innovants. Par exemple, au cours de ces dernières années, nous avons pu réduire de manière significative la consommation d'eau de nos robinetteries et pommes de douche arrosoir.

<sup>ES</sup> La exigencia y la convicción de actuar de forma sostenible nos acompañan desde nuestros orígenes. Una postura que influye en cada decisión sobre calidad, materiales, procesos de fabricación y proveedores. Como firmantes de los objetivos de sostenibilidad de la ONU, en Dornbracht no solo profesamos productos de larga vida y diseños duraderos. También apostamos por una producción sostenible y un uso responsable de nuestros productos: por ejemplo, con nuestro amplio servicio de reparación y restauración. Desde 2021, producimos y comercializamos con neutralidad climática. Para seguir aumentando nuestro compromiso con la protección climática, mejoramos continuamente nuestra eficiencia energética y de recursos con nuestros innovadores productos y soluciones. Así, por ejemplo, hemos logrado reducir de forma significativa el consumo de agua de nuestras griferías y duchas de lluvia.



Explore our  
sustainability projects:  
[dornbracht.com/sustainability](https://dornbracht.com/sustainability)

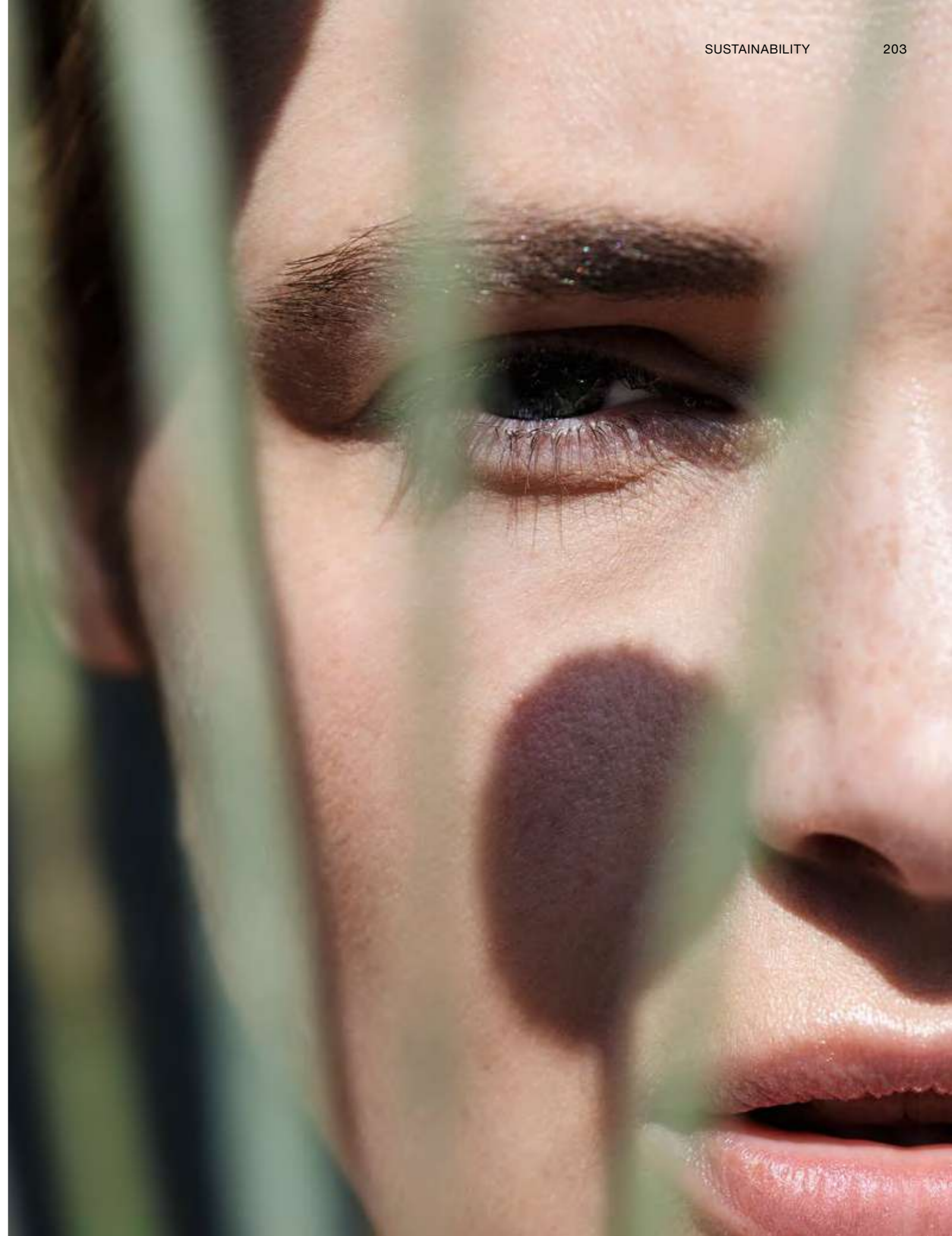



<sup>EN</sup> With Dornbracht ReCrafted, we recondition design icons in original Dornbracht manufacturing quality. Discover our selection now at [dornbracht-recrafted.shop](https://dornbracht-recrafted.shop)

Available in most EU market

<sup>FR</sup> Avec Dornbracht ReCrafted, nous reconditionnons des icônes du design dans la qualité artisanale originale de Dornbracht. Découvrez dès maintenant notre sélection sur [dornbracht-recrafted.shop](https://dornbracht-recrafted.shop).

Disponible dans la plupart des marchés de l'UE

<sup>ES</sup> Con Dornbracht ReCrafted, reacondicionamos iconos de diseño con la calidad de fabricación original de Dornbracht. Descubra ahora nuestra selección en [dornbracht-recrafted.shop](https://dornbracht-recrafted.shop)

Disponible en la mayoría de los mercados de la UE



Find out more on [dornbracht-recrafted.shop](https://dornbracht-recrafted.shop)

# Finishes Overview

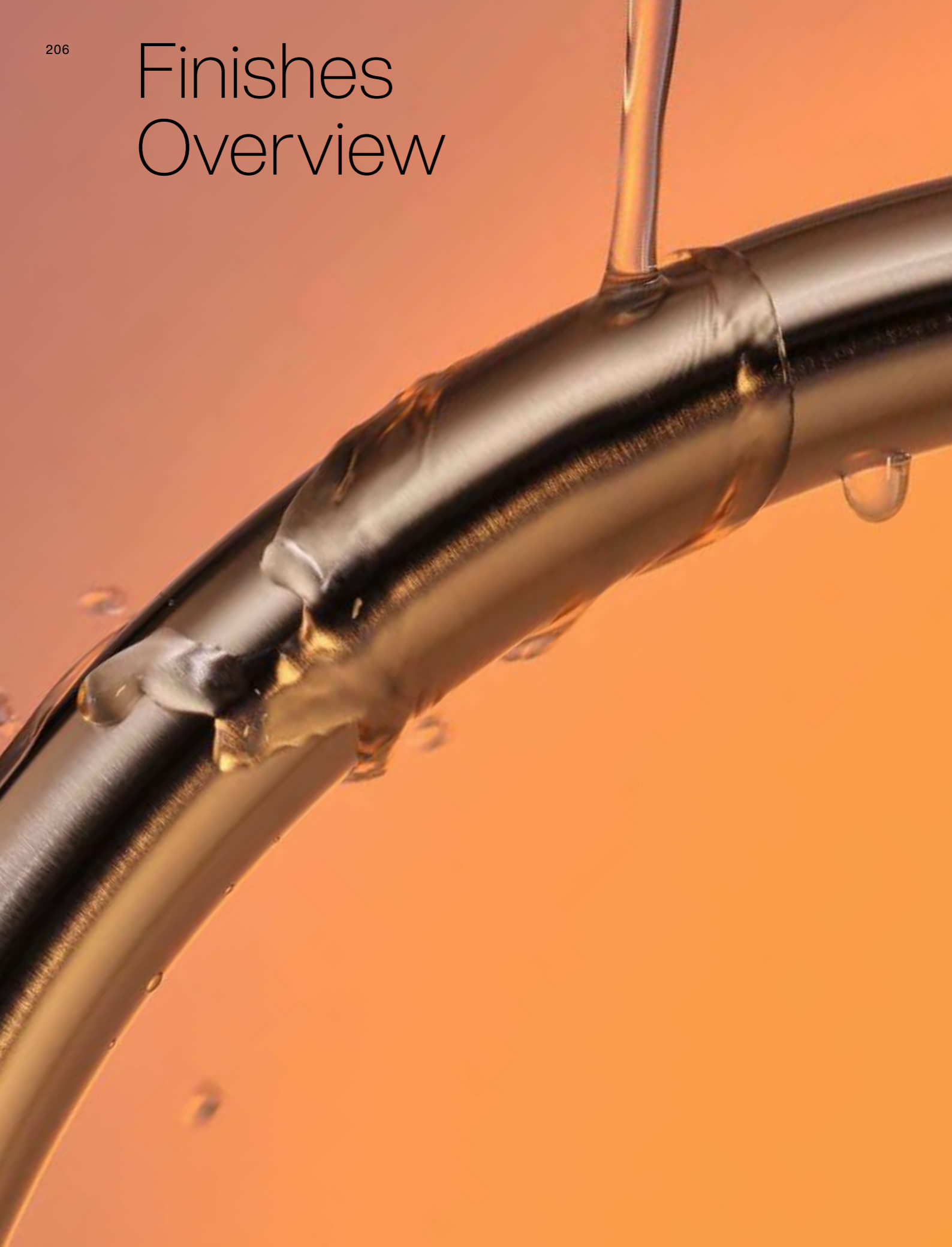

<sup>EN</sup> Our carefully selected finishes offer you a multitude of high-quality solutions for a wide range of styles and architectures. Carefully selected and customized, they offer you the greatest possible design freedom while guaranteeing stylishness and longevity. You have some ideas of your own? Our Dornbracht x-tra Service team will be happy to assist you with tailored solutions.

<sup>FR</sup> Nos finitions soigneusement sélectionnées vous offrent une variété de solutions de haute qualité pour une multitude de styles et d'architectures. Sélectionnées et coordonnées délibérément, elles vous garantissent une liberté de conception maximale et associent maîtrise stylistique et longévité. Vous avez vos propres idées ? Notre Dornbracht x-tra Service met également en œuvre des solutions personnalisées pour vous.

<sup>ES</sup> Nuestros acabados minuciosamente combinados le ofrecen numerosas soluciones de calidad para una gran cantidad de estilos y arquitecturas. Seleccionadas y armonizadas conscientemente, le garantizan la máxima libertad de diseño ofreciendo al mismo tiempo estilo seguro y durabilidad. ¿Tiene sus propias ideas? Nuestro equipo x-tra Service de Dornbracht también plasma soluciones individuales para usted.

DISCOVER MORE ON PAGE 198 →

00  
Chrome  
Chrome  
Cromo

93  
Brushed Chrome  
Chrome brossé  
Cromo cepillado

08  
Platinum  
Platine  
Platino

06  
Brushed Platinum  
Platine brossé  
Platino cepillado

47  
Champagne (22kt)  
Champagne (Or 22cts)  
Champagne (Oro 22k)

46  
Brushed Champagne (22kt Gold)  
Champagne brossé (Or 22cts)  
Champagne cepillado (Oro 22k)

09  
Durabronze (23kt Gold)  
Laiton (Or 23cts)  
Latón (Oro 23k)

28  
Brushed Durabronze (23kt Gold)  
Laiton brossé (Or 23cts)  
Latón cepillado (Oro 23k)

19  
Dark Chrome  
Dark Chrome  
Dark Chrome

99  
Brushed Dark Platinum  
Dark Platinum brossé  
Dark Platinum cepillado

33  
Matte Black  
Noir mat  
Negro mate

# Imprint

Product Design  
Sieger Design

Architecture  
Mike Meiré, Meiré und Meiré

Photography  
Ajay Barai / Unsplash, Johannes Bauer,  
Guillaume Chabrol / Unsplash, Tillmann Franzen,  
Fernando Gomez / Trunk Archive, Jonas von der Hude,  
Thomas Popinger, Alexander Sander

Concept, Creation and Editing  
Meiré und Meiré, Cologne

Printing  
Daneels Media Group, Beerse, Belgium

<sup>EN</sup> We reserve the right to implement model, program, or technical modifications without prior notice. Be inspired and find out more at [dornbracht.com](https://dornbracht.com)

<sup>FR</sup> Sous réserve de modification des modèles et des gammes ainsi que de modifications techniques et d'erreurs. Laissez-vous inspirer et rendez-vous sur [dornbracht.com](https://dornbracht.com) pour en savoir plus.

<sup>ES</sup> Nos reservamos el derecho a modificar modelos o colecciones, así como a realizar modificaciones de carácter técnico, y a haber incurrido en errores. Déjese inspirar y descubra mucho más en [dornbracht.com](https://dornbracht.com)

# Our Services

## 5

<sup>EN</sup> Five year warranty  
<sup>FR</sup> Garantie cinq ans  
<sup>ES</sup> Cinco años de garantía

## 10

<sup>EN</sup> Ten year spare parts service  
<sup>FR</sup> Service de pièces de rechange pendant dix ans  
<sup>ES</sup> Diez años de servicio de piezas de repuesto

<sup>EN</sup> Dornbracht inspires and creates living spaces that are timeless. For all concerns, you can rely on our Dornbracht Service Team to be at your disposal quickly and efficiently.

<sup>FR</sup> Dornbracht inspire et crée des espaces de vie d'une durée intemporelle. Pour toutes vos demandes, notre service client Dornbracht se tient à votre disposition et vous apporte une réponse avec rapidité, simplicité et efficacité.

<sup>ES</sup> Dornbracht inspira y crea espacios de vida de duración atemporal. Nuestro equipo de servicios de Dornbracht atenderá todas sus consultas de forma rápida, fiable y sin complicaciones.

Please note that some country-specific regulations require the installation of complementary products that are sold separately. Some local regulations may require adaptations in specification using an assortment of Dornbracht products. Therefore, the illustrations shown may differ from the final installation in order to be in compliance with regulations. Furthermore, please note that some products shown on the images are not available in every market. /

Veillez noter que certaines réglementations nationales exigent l'installation de produits complémentaires vendus séparément. Certaines réglementations locales peuvent nécessiter d'ajuster les spécifications à l'aide d'un assortiment de produits Dornbracht. Par conséquent, les illustrations présentées peuvent différer de l'installation finale dans un souci de conformité avec les réglementations. En outre, veuillez noter que certains produits illustrés ne sont pas disponibles sur tous les marchés. /

Tenga en cuenta que las normativas de determinados países exigen la instalación de productos complementarios que se venden por separado. Algunas normativas locales pueden requerir ajustes en la especificación al utilizar algunos productos de Dornbracht. Por tanto, las ilustraciones mostradas pueden diferir de la instalación final con tal de cumplir con dichas normativas. Además, tenga en cuenta que algunos de los productos mostrados en las imágenes no están disponibles en todos los mercados.



Dornbracht AG & Co. KG  
Köbbingser Mühle 6, D-58640 Iserlohn  
[dornbracht.com](https://dornbracht.com)



Find out more about our services  
[dornbracht.com/kitchen](https://dornbracht.com/kitchen)

01 00 23 981 18



4099477193526



[kitchen.dornbracht.com](http://kitchen.dornbracht.com)